

Machine type **Palletizer PRESSANT UNIVERSAL 1N**

Machine No. **K R51-373 (22-0441014)**

Year of manufacturing **2002**

Customer

Country of origin **Germany**

Manufacturer address **Krones AG**  
**Werk Rosenheim**  
Äußere Münchener Str. 104  
D - 83026 Rosenheim  
Telefon 08031 / 404-0

---

	Page
<b>0 1 .    Documentation survey</b>	<b>100</b>
0 1 . 0 1    Instructions for use of the operating instructions	
0 1 . 0 2    Groups of the total documentation	
0 1 . 0 3    "EC" declaration of conformity	
<b>0 2 .    Technical data</b>	<b>200</b>
0 2 . 0 1    General data	
0 2 . 0 2    Dimension sheet	
0 2 . 0 3    User instructions	
0 2 . 0 4    Scope of delivery	
<b>0 3 .    Installation of the machine</b>	<b>300</b>
0 3 . 0 1    Transport instructions	
0 3 . 0 2    Unloading	
0 3 . 0 3    Installation and fixing of the connections	
0 3 . 0 4    Initial start-up	
<b>0 4 .    Function description</b>	<b>400</b>
0 4 . 0 1    Machine layout	
0 4 . 0 2    Description	
0 4 . 0 3    Pneumatic plan	
<b>0 5 .    Operating and displays</b>	<b>500</b>
0 5 . 0 1    Description of operating and display elements	
0 5 . 0 2    Instruction for safe operation	
<b>0 6 .    Setting instructions</b>	<b>600</b>
0 6 . 0 1    Machine initial setting and product change-over	
0 6 . 0 2    Alteration of the initial setting	
<b>0 7 .    Machine start</b>	<b>700</b>
0 7 . 0 1    Preparation for the daily start-up	
0 7 . 0 2    Automatic function	
0 7 . 0 3    Manual function	
0 7 . 0 4    Restart after stop	
0 7 . 0 5    Reinstated start-up	

	Page
<b>0 8 .    Machine stop</b>	800
0 8 . 0 1    Intentional, manual stop	
0 8 . 0 2    Automatic stop and emergency stop	
0 8 . 0 3    Intentional shut-down	
<b>0 9 .    Maintenance instructions</b>	900
0 9 . 0 1    Cleaning	
0 9 . 0 2    Check and control	
0 9 . 0 3    Lubrication / greasing	
0 9 . 0 4    Special tools	
0 9 . 0 5    Preventative maintenance	
0 9 . 0 6    Maintenance	
0 9 . 0 7    Instructions for spare and wear parts	
<b>1 0 .    Elimination of faults</b>	1000
1 0 . 0 1    General instructions	
1 0 . 0 2    Fault finding	
<b>1 1 .    Safety</b>	1100
1 1 . 0 1    General regulations	
1 1 . 0 2    Important instructions for the user	
1 1 . 0 3    Safeguards	
<b>1 2 .    Assistance by KRONES</b>	1200
1 2 . 0 1    Customer advice	
1 2 . 0 2    Technical service	
1 2 . 0 3    Spares service	
1 2 . 0 4    Training	
<b>1 3 .    Instructional pamphlet</b>	1300
1 3 . 0 1    Customer specific special functions	
1 3 . 0 2    Instructional pamphlet of suppliers	
1 3 . 0 3    Suitable operation and auxiliary materials	

Amount of pages        : 72

## 0 1 . 0 1 Instructions for use of the operating instructions

Please read the entire Instruction Manual before you install and start the machine / plant.

You will then avoid any incorrect operation of the machine. In your own interest, please observe the safety warnings. You should also read them even if you are already familiar with the operation.

An Instruction Manual can only be of use if it is readily available to the operator. Please, therefore, take care that the Instruction Manual and training is supplied to the operating personnel.

The information supplied in the instruction and other supplementary should not be photocopied or handed to third parties without the prior consent of KRONES.

KRONES works on continuously upgrading and further development for their machines. Our rights to making changes in regard to technique and equipment are therefore reserved.

## 0 1 . 0 2 Groups of the totaldocumentation

- \* Operating Instructions
  - Manual and Maintenance Instruction
  - Pneumatic Schematic (if required)
  - Lubrication Plan (if required)
  - Technical Leaflets Instruction
- \* Electrical Schematic
- \* Programmed Logic Control Listing (includes diskette)
- \* Spare Parts List (includes wearing parts and drawings)

Note:

The Electrical Schematic and PLC Programme will be supplied in their final versions, after the machine / plant has been commissioned, in order that the schematics and listings correspond with the actual version of the installed machine.

## 0 1 . 0 3 "EC"declaration ofconformity

The machines of KRONES comply with the generally established rules of technology and current European law.

On acceptance of the machine on site, the declaration of conformity will be handed over to the customer, and the CE-mark will be affixed to the machine.

## 0 2 . 0 1 General data

* Machine type	PalletizerPRESSANTUNIVERSAL1N
* Main connections	
- Electric	
. Voltage	3 x 460 V 5 %
. Frequency	60 Hz 2 %
. Apparent power	~ 28 KVA
. Real power	~ 19,6 KW
- Pneumatic	
. Overpressure	5 bar
. Melt point	- 5 C
. Filter	40 micro
. Air consumption	max. 4 m3 / h
* Weight	~ 4000 kg
* Floor load	max. 8 x 7500 N
* Aligning view	1
* Noise level	=< 85 dB

The workplace-related emission value is between 75 and 85 dB(A), +- a measuring tolerance of 2 dB, measured according to DIN EN 11204 - accuracy class 2.

Note: This value may increase or decrease depending on the container/product pack to be processed and the machine capacity / building acoustics.

### Safety:

The safety devices comply with European law and the generally established rules of technology.

## 0 2 . 0 2 Dimensionsheet

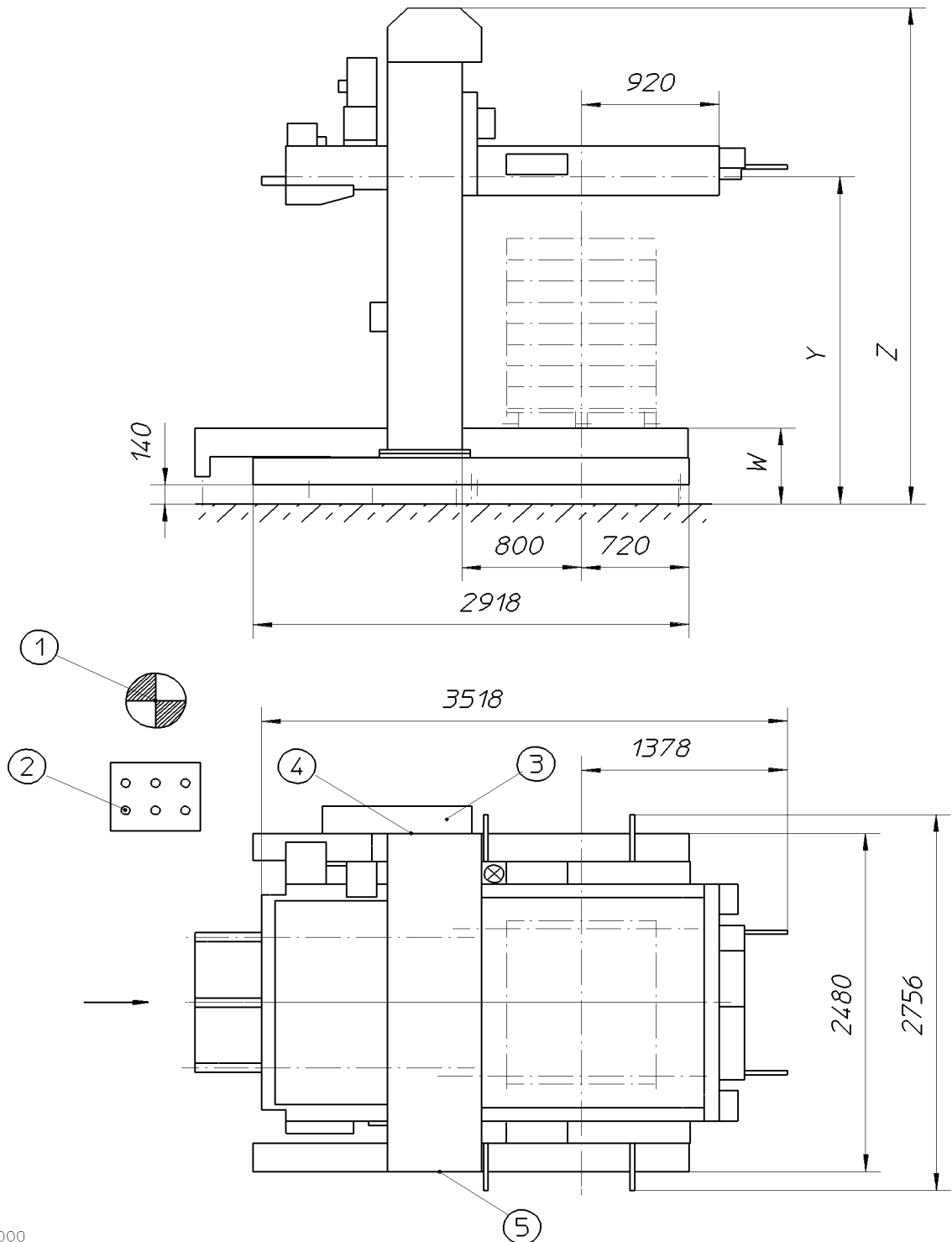

1136800050000

Operating instructions  
Palletizer PRESSANTUNIVERSAL1N  
KR51-373



## 0 2 . 0 2   Dimensionsheet

Numbered items to the diagram:

1 = Operator position

2 = Free standing control desk next to the hoist column

3 = Armatures and terminal block

4 = Electronics connector

5 = Air connector: 1/2" gauge

Y = 2700 mm

Z = 3940 mm

W = 550 mm (pallet running height roller track)



## 0 2 . 0 3 Userinstructions

!! Attention!

!! The machine must only be started under the conditions mentioned below.

!! Using the machine/plant for purposes other than those mentioned

!! is considered contrary to its designated use. The manufacturer/supplier

!! cannot be held liable for any damage resulting from such use.

!! The risk of such misuse lies entirely with the user.

!! The machine/plant must only be used in technically perfect condition

!! in accordance with its designated use and the instructions set out

!! in the operating manual and complying with the inspection and maintenance

!! directives, and only by safety-conscious persons who are fully aware

!! of the risks involved in operating the machine/plant.

!! Any functional disorders, especially those affecting the safety of the

!! machine/plant, should therefore be rectified immediately.

### \* Applicability

The machine is suitable for palletizing whole layers of cartons.

### \* Environmental conditions

Measures are to be taken that the usual environmental conditions found in the dry part of the beverage industry are supplied.

## 0 2 . 0 3 Userinstructions

### \* Performance characteristics

#### - Palletizing variants:

Program 1:

Product: 0,5 l PET bottle

Type of product pack: carton of 24 bottles (393,7 x 263,5 x 231,8 mm)

Pallet dimensions: 1219x1016x133mm

Type of palletizing: palletizing of interlocked patterns

Product packs per layer: 10

Layers per pallet: 7

Stacking height incl. pallet: 1756 mm

Capacity: 1800 packs/h, 180 layers/h = 19,2 s/layer

---

Operating instructions

Palletizer PRESSANTUNIVERSAL1N

KR51-373



## 0 2 . 0 4 Scope of delivery

The machine is normally arranged in the following assembly groups:

- \* Base frame
- \* Columns
- \* Hoist
- \* Loading station
- \* Grouping station
- \* Safety guarding
- \* Electronic equipment
- \* Pneumatic equipment

Specification of the individual assembly groups:

- \* Base frame

Robustly constructed from I-beam carriers,  
all parts supplied are of a high quality and further protected by a plastic  
coating, all pneumatic piping and electrical cabling are carried in ducting with  
easily removable cover plates.

## 0 2 . 0 4 Scope of delivery

### \* Columns

The generously sized tubular construction ensures high operational reliability and low vibration operation of the machine.

The maintenance unit and the EMERGENCYSTOP switch have been arranged in such a way that they can be easily operated. The screwed and hardened guide rails can be easily exchanged and provide high resistance to wear.

An integrated safety latch is optionally available for the hoist.

### \* Hoist

consisting of a drive unit with toothed belts and counterweights. Equipped with a frequency-controlled spur wheel back-gearred brake motor which is connected to a single spur gear via a cardan shaft.

Through the use of a frequency converter, the drive unit ensures high positioning accuracy and optimum dynamics of movement for the hoist. The counterweights and the geared motor with a high efficiency help to save energy.

### \* Loading station

Robust construction method by using proven elements. Optimised dynamic movement by using frequency controlled drives. Loading plate optional consisting of rust free, bead shape (surface) profile plate for friction reduction.

Automatic adaption to different layer patterns by motor driven guide adjustment (optional) and simple construction of the layer pusher.

## 0 2 . 0 4 Scope of delivery

### \* Grouping station

Corrosion-resistant grouping station with a frequency-controlled row pusher, consisting of the infeed section with rollers and spacers, and the pre-grouping section with a plate.

The angle at the end of the pre-grouping section serves as stop for the layer of product packs.

Light barriers and proximity switches for position measurement. Driven by three-phase A.C. motors.

### \* Safety guarding

Secure, firmly attached safety fences with safety light barriers as per customers' requirements.

### \* Electronics installation

Stored, programmable logic control (PLC) with control supply voltage of 24 V-DC, or otherwise installed according to KRONES standard specification.

The cables are laid in the machine frame or in cable ducts. Where necessary in conduit.

Drive with a frequency regulator unit (partly).

The cabinet is free-standing.

The main control desk is free-standing.

### \* Pneumatic equipment

complete by Bosch.

## 0 3 . 0 1 Transport instructions

In order to avoid transport damage, the following should be noted:

- Guarantee a safe position for the machine on the lorry or wagon etc.
- Machine to be secured (ropes, chains, wedges...)
- Also when the customer collects the equipment, the relevant safety measures are to be adhered to.
- When storing the machine outside, it is to be covered.
- The console doors must be closed.
- For the transport on low-lying trucks the machines must be cover.
- The brakes of all electrical motors must be open.
- The machine must be secured against free movements of the individual assembly groups (according to regulations brake intervention by all drives).  
If necessary provide additional locking devices, e.g. for lifting trucks, pivot arms, booms etc. (if provided).

## 0 3 . 0 2 Unloading

KRONES is not liable for machine damage caused by non-observance of the machine handling recommendations!

On arrival the shipment should immediately be checked for transportation damage.

Use the eyebolts of the cross traverse on the hoist when using lifting gear.

## 0 3 . 0 3 Installation and fixing of the connections

!! Attention !

!! Working on electrical and pneumatic devices may only be carried out by specialist.

!! Take care of the connecting values.

\* The assembly area of the machine (refer to line layout plan) must be a clean and levelled.

\* The machine must be accessible for service and maintenance.

\* The corresponding safety measures are to be adhered to.

\* The following actions are to be done:

- Cleaning of the machine.
- Threaded spindles for foot plates to be screwed on with locking nuts under the machine frame.
- Machine to be put onto the foot plates, or mounted onto intermediate legs as required.
- Machine to be levelled by means of the threaded rods.
- Align the machine to its height according to the line layout plan.
- Locking tightened.
- Remove the transport safety guards.
- Fit magazine feeder (if provided).

## 0 3 . 0 3 Installation and fixing of the connections

The machine is fully pre-wired so that when commissioning it, only the following connections have to be made (see the technical data):

\* Electrical

- Main connection - Control cabinet
- electrical cabinet - safety devices
- Control cabinet - machine (when control cabinet self-supporting)
- Control cabinet - Operator console (when operator console self-supporting)

\* Pneumatic

- Main connection - machine
- Inner diameter of the pneumatic infeed: min. 13 mm



## 03.04 Initial start-up

!! Attention !

!! Please make sure that the personnel involved are instructed in the safety

!! concept and the in the safety regulations of the machine / plant.

The initial commissioning may only be done by KRONES trained personnel!

To satisfy the need for timely training, the staff at the client's plant (i.e. operators, electricians and fitters) should be made available for training.

Essentially, the following should be noted:

- All main switches (electrical, pneumatic) to be set in the "OFF" position.
- Product containers (e.g. articles, carton blanks, crates) ready to run.
- Working area to be cleared (e.g. folding cartons, crates, glass debris, tools, cleaning rags...).
- Supply connections checked (see technical data)
- Air pressure manual slide connector in "ON" position (air maintenance unit).
- Electronics supply main switch is "ON".
- Check, if all the doors of the control cabinets are closed.
- Functional check of the main light barriers, proximity switches, and also the LED indicators in the switch cabinet on the SPC.
  
- Visually inspect the control panel (display, buttons)
- Check the air pressure. Set the air pressure to the specified values on the pressure reducing valves (e.g. maintenance unit)
- Check the function of all the sequences of movement step by step in manual or inching mode.
  
- Subsequent re-adjustment of light barriers, proximity switches...
- Functional check of various automatic machine programmes...
- Instruction of the operating and maintenance personnel at the plant.

## 0 4 . 0 1 Machine layout

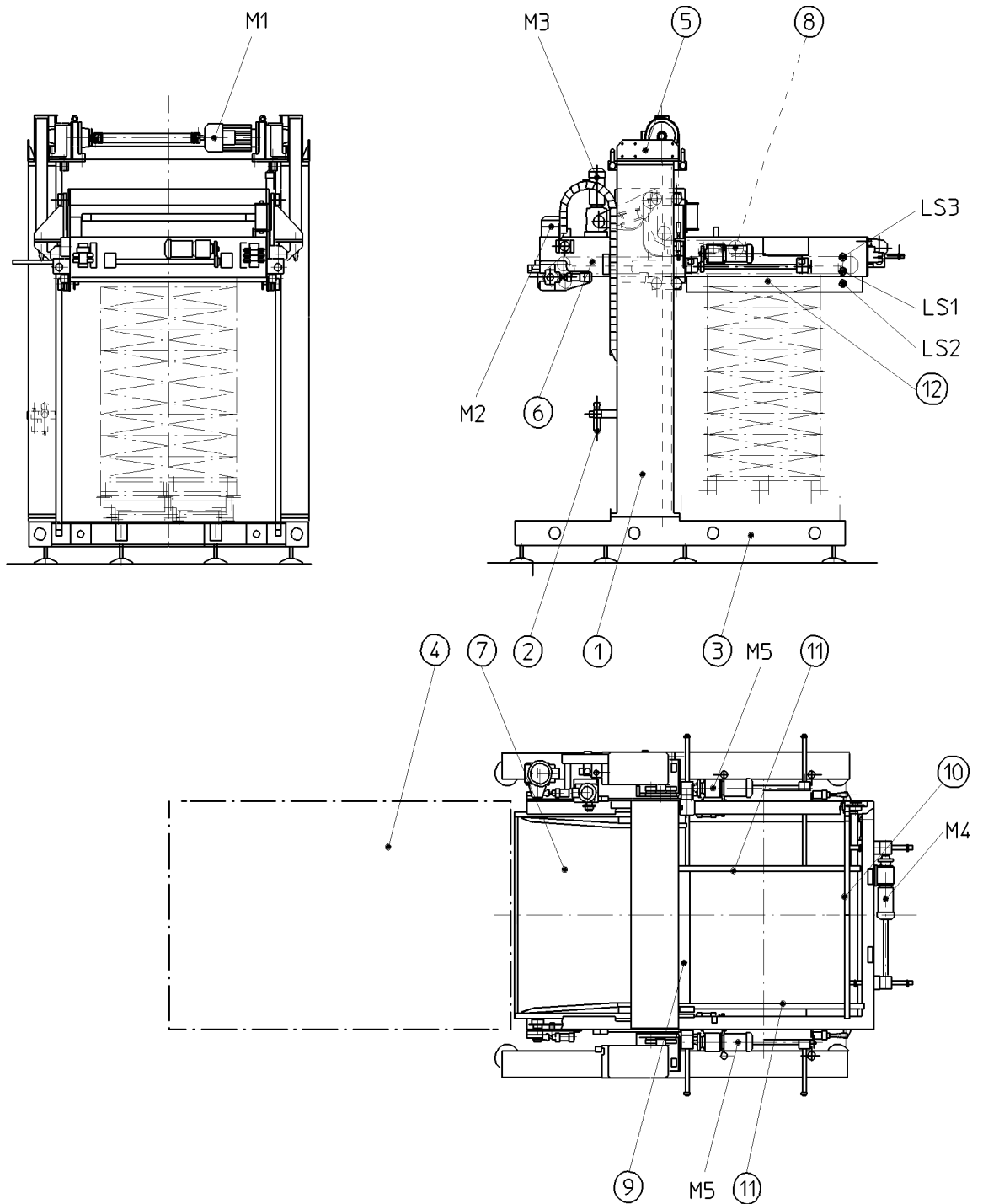

M1368005.1-MU

Operating instructions  
Palletizer PRESSANTUNIVERSAL1N  
KR51-373



## 0 4 . 0 1 Machine layout

Item numbers for machine overview:

- 1 = columns
- 2 = maintenance unit
- 3 = base frame
- 4 = grouping station

Hoist:

- 5 = hoist
- M1 = hoist drive

Light barriers:

- LS1 = hoist stop
- LS2 = hoist slowly down (custom-built)
- LS3 = hoist slowly up (custom-built)

Note:

The light barriers LS2 and LS3 are built in according to the difference of height between the grouping station and the pallet conveyor:

- . If the difference is more than 1300 mm, only the light barrier LS2 is used,
- . between 450 and 1300 mm, the light barriers LS2 and LS3 are used,
- . less than 450 mm, only the light barrier LS3 is used.

Loading station:

- 6 = loading station
- 7 = transfer carriage
- M2 = transfer carriage chain drive
- 8 = layer pusher
- M3 = layer pusher chain drive
- 9 = pneumatically operated retaining bar (custom-built)
- 10 = stop bar
- M4 = stop bar drive
- 11 = lateral guide adjusting mechanism

---

Operating instructions

Palletizer PRESSANTUNIVERSAL1N

KR51-373



## 0 4 .0 1 Machine layout

M5 = drive of lateral guide adjusting mechanism

12 = pneumatically operated layer centering device (custom-built)

The exact specification for the drive and signal elements of the commission dependent operation is derived from the individual machine elements!

## 0 4 . 0 2 Description

### Operating modes

The machine is equipped with 2 operating modes:  
AUTOMATIC and MANUAL.

### AUTOMATIC-Operation:

In automatic operation the machine works in a cycle, whereby the following group functions occur:

- \* Pallet transport to and from the machine
- \* Product pack transport and product pack supply
- \* Infeed of the product packs in the grouping station and pre-formation
- \* Row transfer to pre-grouping area
- \* Layer transfer of the container layer into the loading station
- \* Horizontal movement of the loading truck in the direction of the pallet and return
- \* Vertical drive of the loading station

The movements within the function groups are controlled sequentially.  
The timing of the functional sequence of the groups is partly parallel. The operating speeds of the function groups are matched in such a way that a trouble-free and continuous operation is achieved. The sequence of functions within the individual function groups is described in the following section.

## 0 4 . 0 2 Description

Description of the function sequences:

- \* Pallet transport to and from the machine

The pallets are fed in as per customers' requirements lengthwise or crosswise to the palletiser, singly or in pairs. The same applies for the transport of the loaded pallet/s.

Transport elements are either chain conveyor or roller conveyor sections. The infeed of the empty pallet runs simultaneously with the discharge of the full pallet. The positioning of the empty pallet in the machine takes place with the aid of light barriers or of pneumatic stoppers and light barriers.

- \* Product pack transport and product pack supply

Rectangular containers are conveyed singly or via one or multiple conveyors to the infeed belt of the machine. According to lay-out, the infeed takes place cross- or lengthwise.

According to the requirement the containers run into the grouping station via a turning station and are then stopped by an adjustable buffer.

After recording the correct number in each container row, the conveyors in the grouping station are ready for infeed.

## 0 4 . 0 2 Description

- \* Infeed of the product packs in the grouping station and pre-formation

Via one or more transfer belts, containers are transported in rows into the grouping station. By means of speed differences of transfer belt and row roller conveyor of the grouping station, a counting gap forms, necessary for the counting of each container. To customers' requirements, these containers are turned 90 (not required with external turning).

When a row has been fed in, it is checked through a light barrier for the required number of containers. The same checking is applied to check for one container too many on this infeed.

It is often necessary to produce gaps between containers in order to achieve certain formations. These gaps are formed through separator blades which drive up pneumatically between the rollers of the infeed conveyor of the grouping station (spacers) and keep distances between the individual containers. The control of the spacers is made by row measurement. The row measurement takes place by means of position measurement.

- \* Row transfer to pre-grouping area

After infeed of a complete container row, the row pusher bar pushes them to the pre-grouping area up to the "pre-grouping" limit switch position. Thereafter the row push bar rise vertically up and away from each row and then back to its original position. In the meantime, a further container row can be infed into the grouping station.

If one case has not been fed in correctly (i.e. if the control light barrier is dark) then the row pusher bar is not started.

The case which has caused the problem must be put into the right position manually. When the control light barrier is bright, the row pushing continues.

## 0 4 . 0 2 Description

- \* Layer transfer of the container layer into the loading station

When pushing over the last row of a layer, the row pusher moves beyond the pre-grouping section and pushes the layer into the loading station. The loading station and the grouping station are on the same level.

The row pusher bar stops in its forward position at the "row push bar - loading station". After the actuation of the limit switch "pre-grouping" in the area of the loading station, more containers are fed into the grouping station. After reaching the position "row push bar - loading station", the row push bar drives up and away from the row and back into its original start position.

- \* Horizontal movement of the loading truck in the direction of the pallet and return

The horizontal movement of the loading wagon is started when the row pusher travels back and the light barriers for depositing the layer (hoist stop) are bright. When this light barriers are dark the loading station travels upward until the light barrier is bright.

After reaching the position "loading wagon on pallet" the layer pusher which is driven by a chain drive from its start position via a count impulse until the layer is positioned precisely above the pallet.

If the loading station has a custom built automatic guide adjustment then the centring of the layer above the pallet is carried out by means of an electrical driven rack.



## 0 4 . 0 2 Description

When the layer is centred and the pallet is positioned vertically under the hoist, the loading carriage travels from under the layer to be deposited to the direction of the grouping station and start position.

By these means the layer is deposited onto the pallet.

The layer pusher travels back to its start position after the loading carriage is on the grouping station side again.

The buffer bar travels back and the side centring opens.

The retainer bar (if existing) moves out in downward direction.

### \* Vertical drive of the loading station

After the loading procedure the loading station travels back to the level of the grouping station by which the loading procedure begins anew.

If a pallet is completely loaded then the loading station travels so far up until an induction switch "loading station STOP" is activated and an adjustable time has elapsed. Due to this the pallet is clear from the loading station and can be turn if required and/or discharged for the next pallet change.

## 0 4 . 0 2 Description

For this machine several palletising programmes have been provided in the AUTOMATIC mode, which differ in accordance to the different types of container (e.g.: cartons, trays, sacks, crates).

### Preparation

- Debris and other foreign objects are to be removed from the machine (empty the machine!).
- On the control desk selection of:
  - . programme
  - . layers
  - . layer boards (if required)
- Clear PLC
- Minimum reserve containers at palletiser  
no case accumulation at depalletiser
- No pallet accumulation at the discharge
- Reserve pallets on the infeed

The machine now travels in automatic if it is in the required start position for the automatic cycle (e.g.: hoist up, grippers opened).

### Execution

The pallet is loaded (palletiser) with the selected amount of layers (control desk) or unloaded (depalletiser) and then leaves the machine.

### Hand:

For this operation mode visual contact of the operator to the machine is definitely required. This operation mode is provided for during and after maintenance work or for adjusting work.

## 0 4 . 0 3 Pneumatic plan

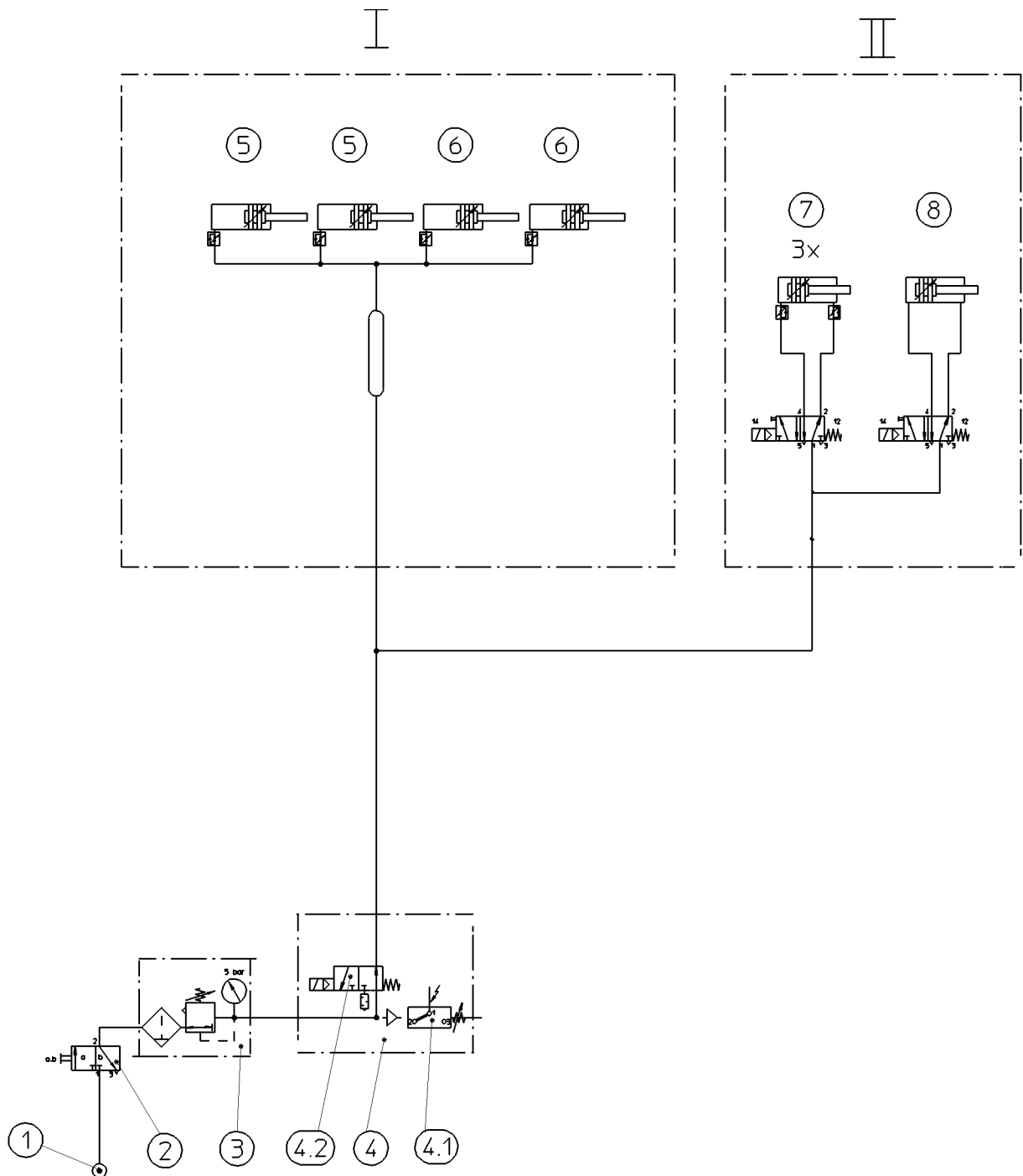

22-0441014-PP

## 0 4 . 0 3 Pneumatic plan

Numbered items for the pneumatic layout:

- 1 = air supply pipe
- 2 = hand sliding valve
- 3 = maintenance unit
- 4 = pressure control device
  - 4.1 = pressure switch
  - 4.2 = valve for switching off pressure

I Loading station:

- 5 = chain tensioner of loading carriage
- 6 = chain tensioner of layer pusher

II Grouping station:

- 7 = case spacer
- 8 = case buffer on pre-grouping section

## 05.01 Description of operator controls and display elements

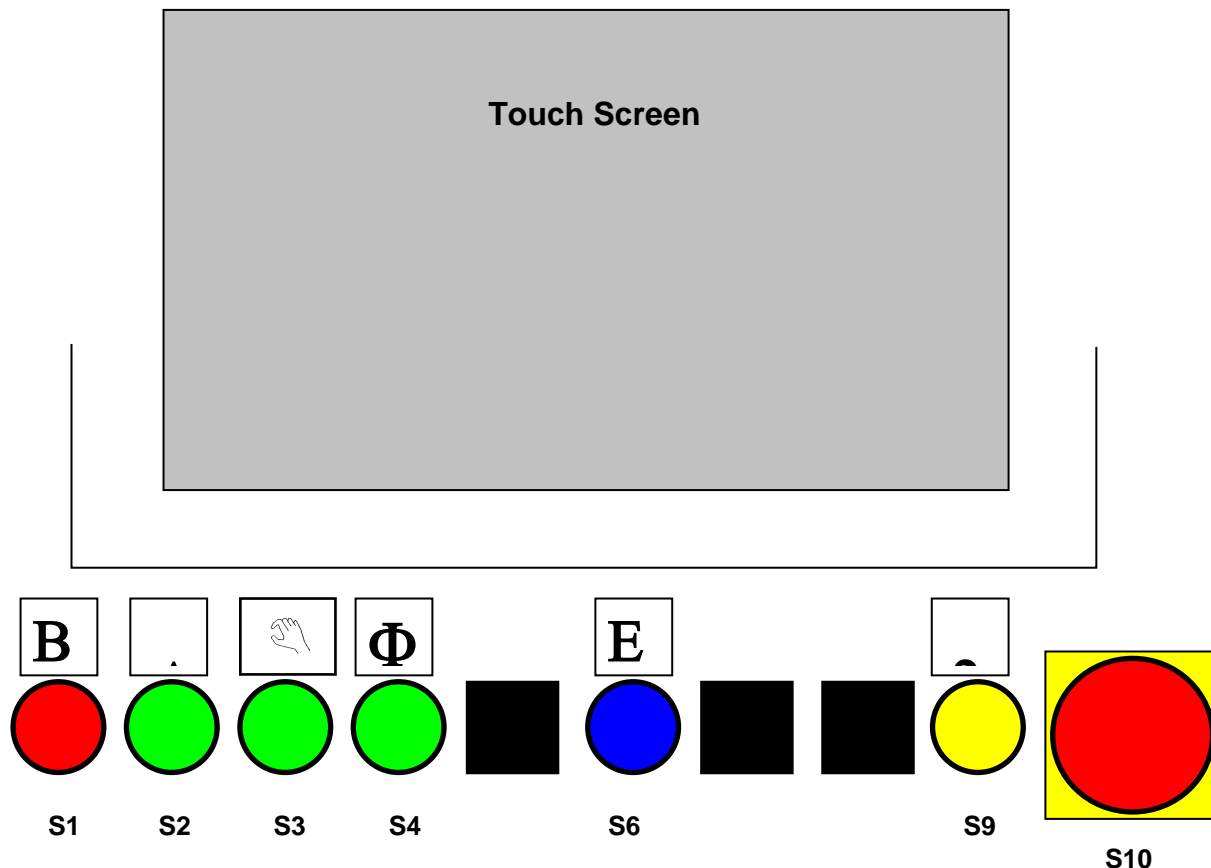

- S1** : Push-button (red) : Switching off
- S2** : Illuminated push button (green): Switching on automatic / activation of manual function  
*Flashing light = hand or automatic preselected*  
*Continuous light = hand or automatic switched on*
- S3** : Illuminated push button (green): Preselection of manual operation  
*Continuous light = manual preselected*
- S4** : Illuminated push button (green): Preselection of automatic operation  
*Continuous light = automatic preselected*

<b>S6</b> :	Illuminated push button (blue):	Fault acknowledgement <i>Continuous light = fault that can be acknowledged</i>
<b>S9</b> :	Indicating light (yellow):	Fault indication <i>Continuous light = machine or safety fault</i> <i>Flashing light = communication fault PLC – touch-screen</i>
<b>S10</b> :	Push button	Emergency stop <i>can be locked by a padlock</i>

The free positions S5, S7, S8 can be occupied by special functions, according to the customer's desire.

The control desk is equipped with a **touch screen**. By means of this touch screen the machine can be set up, operated and monitored.

### Important:

- Observe all messages which are displayed on the touch screen.
- The operating functions are initiated by softly touching the buttons.
- When working on the touch screen, do not use sharp objects.

Depending on the design of the machine, operator controls may be described which are not available on your machine. The figures are examples; depending on the machine, the controls and displays may have different appearances.

## 1. Survey image

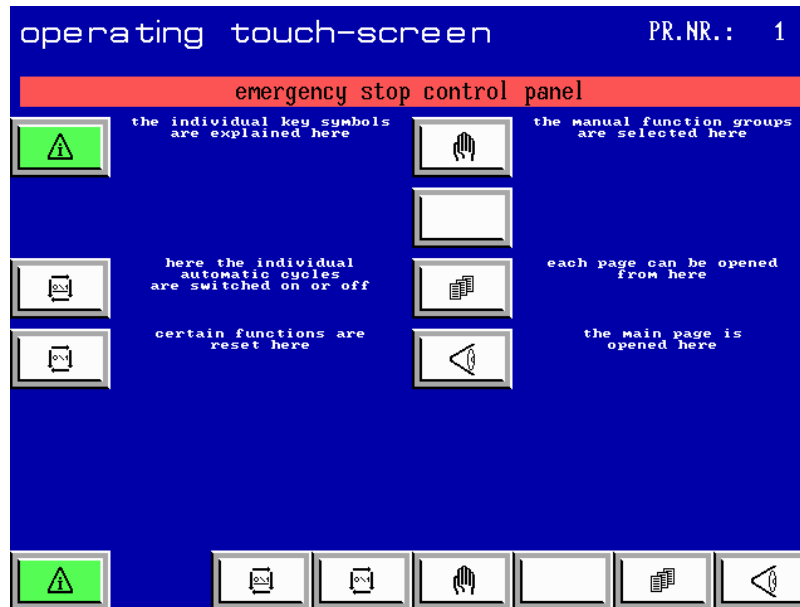



This image appears after the machine has been switched on. It shows a survey of all the symbols used for the buttons (bottom bar) including explanation.

All images can be selected from this page.

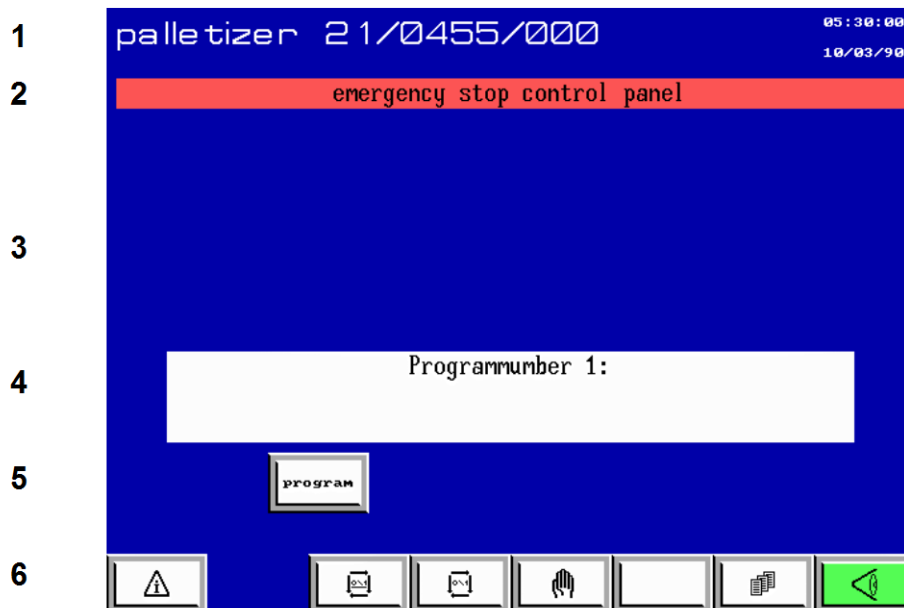
## 2. Product data image and program selection



### Function of the displays and buttons

- 1 Indication of machine type, time, date
- 2 Indication of current messages and malfunctions
  - This display remains indicated with any other menu image selected ! -
- 3 Buttons for setting the number of layers (not always existing)
  - press the button: a numerical keypad appears
  - enter the desired number
  - press ENTER (on the numerical keypad)
- 4 Indication of the program currently set
- 5 Button for program selection
  - + scroll forward  accept
  - scroll backward  cancel
  - 1 direct program selection
- 6 Buttons for calling up further images (see following pages)  
Explanation of the symbols: Call-up of the survey image via the button "i"



## 3. Main functions

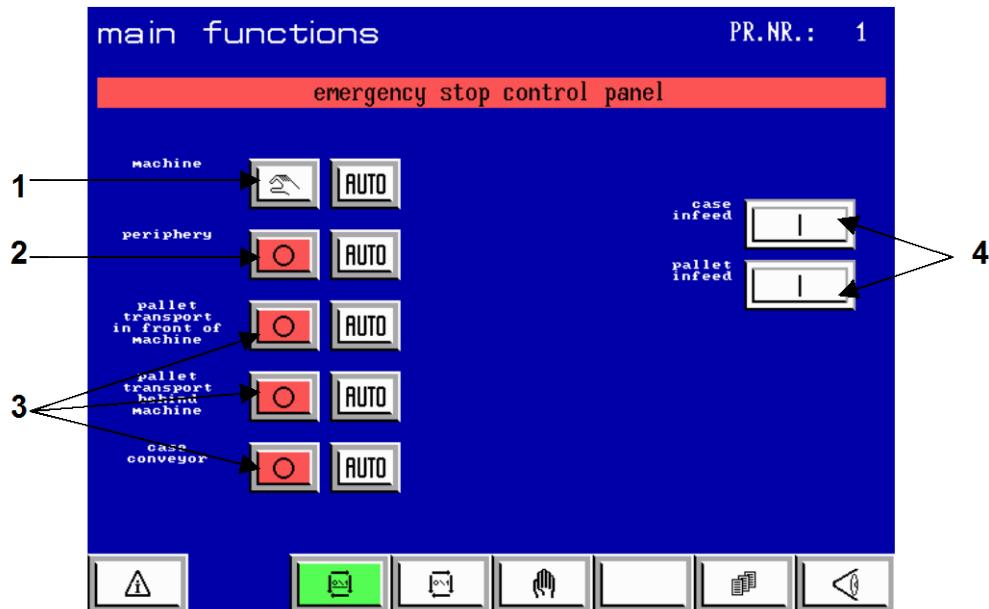

### Function of the buttons:

- 1 Button for switching the machine to manual or automatic operation. The operating mode currently set is illuminated.
- 2 By means of this button all the peripherals of the machine can be either switched off or switched to automatic operation.
- 3 By means of these buttons, individual peripheral units of the machine, f. ex. pallet transport, can be either switched off or switched to automatic operation.
- 4 By means of these buttons the infeeds into the machine (or other peripheral units) can be switched on or off.

## 4. Additional functions

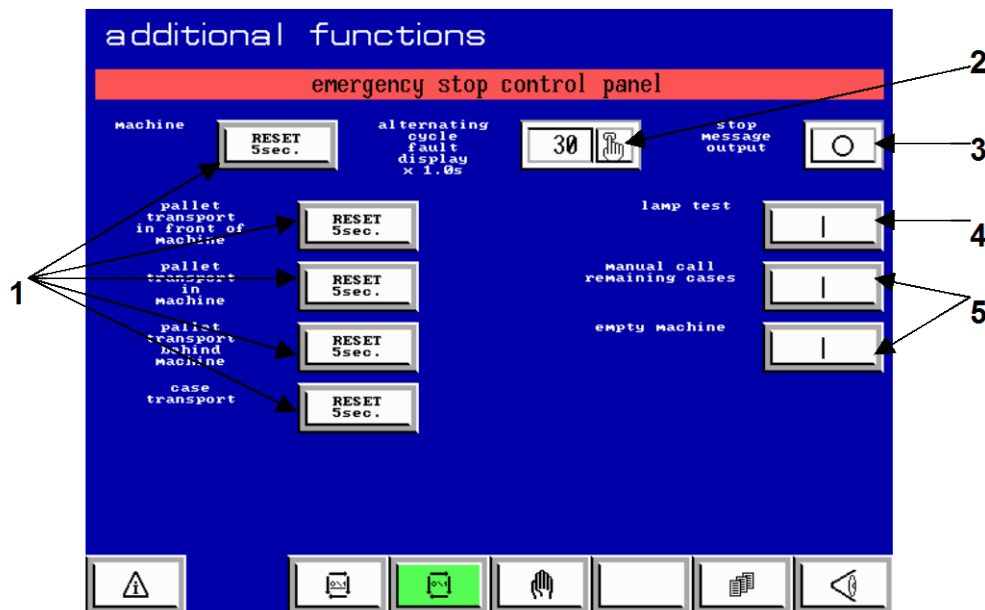

### Function of the buttons and displays:

- 1 By means of the RESET buttons the machine or individual machine peripherals can be reset.  
The reset is only carried out, if the button is actuated for more than 5 seconds.
- 2 Button for setting the display time of the individual malfunction messages in the case of there being several malfunctions.
- 3 By means of this button the display can be prevented from changing to the next message. Thus long texts can be read more easily.
- 4 Button for the function check of all the indicator lamps and illuminated displays  
- Perform check before each start of production! -  
Replace defective lamps, in order to ensure that the respective malfunctions or operating signals can be indicated.
- 5 Buttons for specific machine settings, f.ex. for starting the function “emptying the machine” when a pallet that is not complete shall be discharged (not always existing).

## 5. Manual functions

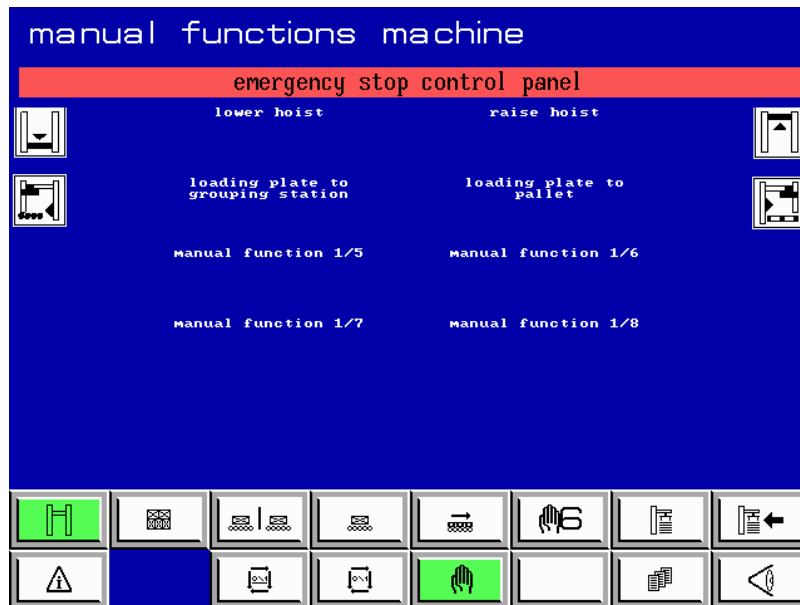

Each machine has different manual functions. The figures shown serve as examples.

When the image "manual functions" is called up via the respective symbol in the bottom bar, only the texts of the 1<sup>st</sup> manual function group are displayed. The related buttons are not displayed. At the bottom of the screen a second symbol bar appears. It contains buttons for the manual function groups which correspond to different machine units. The desired manual function group can be selected by pressing a button; the image with the related individual manual functions is displayed.

In order to activate a manual function, first the button S3 "preselection of manual" has to be pressed on the control desk. This brings up the buttons. Then the desired button has to be pressed, and the manual function has to be activated on the control desk by means of the push-button S2.

### **Warning!**

The manual operation of the machine requires an exact knowledge of the functional sequences!

Operating errors may cause injuries or machine damage!

When manual functions are performed, no persons may be within the danger area.

## 6. Manual functions

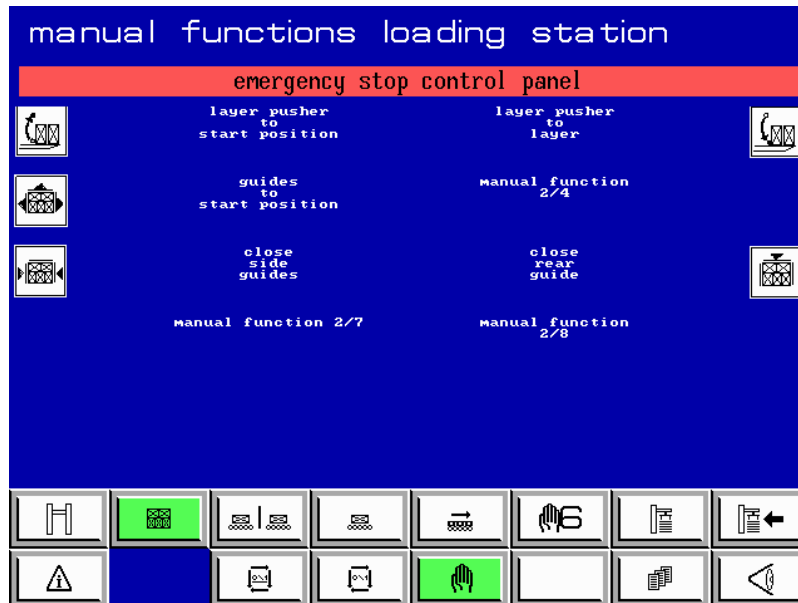

By touching a button of a manual function group, in the symbol bar, an image with buttons for the individual manual functions of this group is displayed. (Activation of the manual functions: in the same way as with group 1, see previous page).

## 7. Image selection

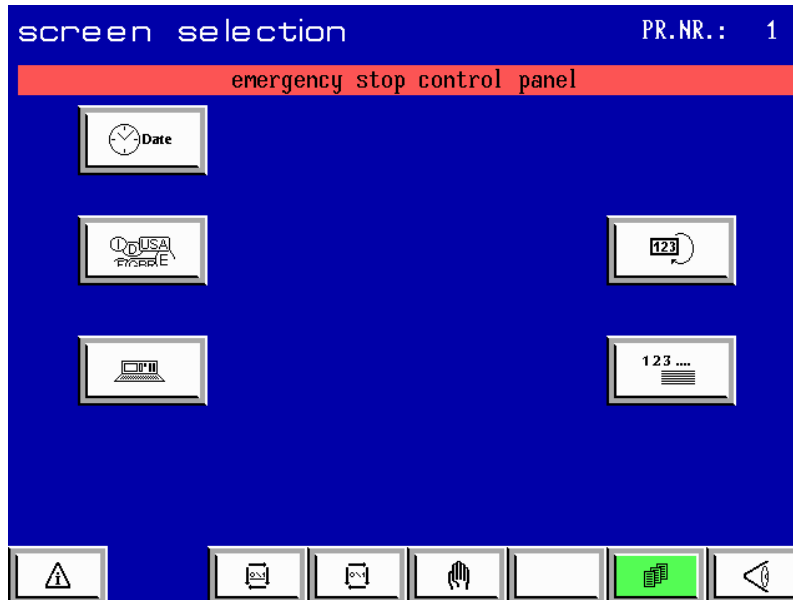

This menu shows a survey of further images of the machine, which can be selected from this screen. By pressing the button "i" explanations of the symbols displayed on the screen are given.

- **Set clock and date**  
In this image the date (day, month, year) and the time (hours, minutes, seconds) which appear in the product data image can be set.
- **Change language**  
Change of the texts in all images to a foreign language (if available)
- **System functions**  
Image for special settings in the program  
*Only accessible with password!*
- **Process data**  
In this image machine specific counters are displayed.
- **Intermediate layer preselection** (if available)  
This image serves to determine after which layer on the pallet an intermediate layer is to be inserted.

## 05.02 Instructions for safe operation

The design of the machine complies with the requirements of the EC machine directive.

However, the industrial and operating safety is only ensured, if the following instructions are obeyed:

- ! The machine must be operated only by operating personnel which have been introduced to the applicable safety instructions.
- ! Due to reasons of safety the operator must be within the operating range of the control desk, when the machine is running.
- ! Observe the instructions given for the individual operating modes.
- ! Always operate the machine with care and awareness of safety.
- ! The safety devices must not be by-passed or deactivated.
- ! Damaged safety devices must be replaced or repaired immediately.
- ! Damaged electric devices and cables must be repaired immediately by the respective expert personnel.
- ! Modifications, attachments or rebuilds to/of the machine/plant which may affect the safety, as well as modifications of the control concept (hardware and software) may not be made without written authorisation of the manufacturer.  
This also applies to the installation and adjustment of safety devices as well as to the welding work on structural members.  
(For permissible interventions in the software which do not affect the safety see control diagram).

## **0 6 . 0 1    Machine initial setting and productchange-over**

The commissioning of the machine is done according to KRONES's trial run process.

If the dimensions of the articles or cases change then machine/plant setting is required. This can be done by a trained user.

!! Warning!

!! Only qualified technical personnel which has been trained by KRONES is

!! allowed to work on the system.

On this machine, no mechanical adjustments are required, because only one product type is processed.

## **0 6 . 0 2    Alteration of the initialsetting**

In case of considerable deviations between the products to be processed and the samples or if a new product is introduced, a change in the basic setting is necessary. This can only be done by suitably trained KRONES personnel !

## 07.01. Preparation for the daily start-up

- \* Check that the machine is free from articles, broken pieces of glass, tools, cleaning cloths,...
- \* Open the sliding valve on the pneumatic maintenance unit.
- \* Check the air pressure.
- \* Switch the main switch on the electric control cabinet to ON.
- \* Check that the operation is to be continued with the program of the previous day; if yes, then initiate the AUTOMATIC operation.
- \* If a new product is used, then set the program selection and, if necessary, the special functions.
- \* The machine must be free from articles.
- \* If necessary, also adjust the machine to the new product mechanically (see chapter 06.01).
- \* Make available the articles to be processed.
- \* Initiate the AUTOMATIC operation (see chapter 07.02).

**!!** Warning!

**!!** Before each machine start-up ensure, that no persons are within the danger area (e.g. swivelling range of the machine)!

Note:

The safety device can only detect persons entering the protected area, but it cannot detect persons who are inside this area.

**!!** After each machine start-up pay increased attention to the sequence of movements of the machine as well as to unusual noises.



## 07.02. Automatic function

In order to initiate the AUTOMATIC operation of the machine, proceed as follows:

- \* Check that the correct program has been selected, and that it corresponds to the basic machine setting.
- \* Release the EMERGENCY STOP switch S10, close the safety doors.
- \* Press the reset button S6 (malfunction indicator).  
If there are malfunctions, these are displayed in the message line of the screen (see chapter 10.02).
- \* Eliminate malfunctions completely and reset.
- \* Pre-select the AUTOMATIC operating mode by means of S4.
- \* Start the AUTOMATIC operating mode by means of S2.

The machine starts.

- !! Warning!
- !! Before each machine start-up ensure, that no persons are within the danger area (e.g. swivelling range of the machine)!

Note:

The safety device can only detect persons entering the protected area, but it cannot detect persons who are inside this area!

- !! After each machine start-up pay increased attention to the sequence of movements of the machine as well as to unusual noises.

## 07.03. Manual function

- !! Important!
- !! The machine control desk is to be set up in such a way that all the machine
- !! movements which can be activated by the manual function can be observed
- !! by the operator!

In the MANUAL operating mode individual machine functions (especially movements) can be activated on the machine control desk in the following way:

- \* Release the EMERGENCY STOP switch S10, close the safety doors.
- \* Press the reset button S6 (malfunction).  
If there are malfunctions, these are displayed in the message line of the screen.
- \* Eliminate malfunctions and reset.
- \* Switch off the AUTOMATIC operating mode by means of the button S1.
- \* Call up the desired manual function image via the buttons on the screen.
- \* Press the button „pre-selection manual function“ S3, the buttons of the manual functions appear.
- \* Press the button of the desired manual function.
- \* When the button S2 is actuated, the manual function is carried out, in most cases as long as the button remains actuated.

During the text display "limit stop switch malfunction" the MANUAL operating mode can be selected nevertheless, so that the respective limit stop switch can be "cleared".

### Note:

Movements which would result in machine parts colliding during the MANUAL operation are not performed by the machine (locked!).

However, movements which may damage articles to be packed are not locked.

## 07.04. Restart after stop

The actions required for restarting the machine after a stop depend on the causes (e.g. fault) of the machine stop that has occurred.

Depending on the kind and the cause of the machine stop different actions have to be taken:

Intentional stop by actuating the OFF button S1:

If after that the overall condition of the machine has not been changed by further operating actions, the ON button S2 has to be actuated to continue the operation.

Stop in the case of faults:

Faults indicated on the control desk have to be eliminated.

!! Important!

!! After the faults have been eliminated the following actions have to be taken:

- !! - close the safety doors
- !! - acknowledge the safety area
- !! - release the EMERGENCY STOP switch
- !! - reset the fault messages
- !! - activate the AUTOMATIC operation again.

## 07.05. New start-up after interruptions of operation

- !! Warning!
- !! If electrical or mechanical work has been carried out on the machine, then  
!! check that all the changed parts have been mounted properly and completely,  
!! before starting-up the machine again!
- !! After interruptions of several months check the proper functioning of all the  
machine movements by means of the MANUAL operating mode, before  
starting the AUTOMATIC operation.
- !! Check all the safety devices.

The following actions have to be taken, when starting-up again after interruptions:

- Clear the working area (e.g. of cases, article packs, broken pieces of glass, tools ...)
- Check the lubrication.
- If there is maintenance unit, replenish it with oil.
- Check the oil level of the geared motors, and replenish, if necessary.
- Check all the pneumatic devices and components of the machine for proper performance and for leaks.
- Replace defective parts.
- For the further procedure see chapter 07.01. and 07.02.
- The starting condition for the automatic operation is to be ensured.

## 08.01. Intentional manual stop

The machine can be stopped at any time during the AUTOMATIC operation.

Operating action: Actuate the OFF button S1.

To ensure a trouble-free restart it is advisable to wait until the current cycle has been completed or possibly even until the end of the program has been reached, before stopping.

**!!**    Warning!

**!!**    Do not enter or reach inside the machine, unless the EMERGENCY STOP switch  
**!!**    has been pressed.

## 08.02. Automatic stop and emergency stop

- !! Warning!
- !! In the case of danger for persons, or other emergencies immediately press
- !! the nearest EMERGENCY STOP switch provided for the machine.
- !! On the machine control desk there is always an EMERGENCY STOP switch.

For the subsequent restart see chapter 07.04.

If events occur during the operation which could cause faulty work or damage on machine parts - e.g. persons entering or leaving the danger area, or malfunctions - the machine stops automatically and displays the cause of the stop on the control desk in the following way:

- The illuminated push-button S9 goes on.
- The malfunction message is displayed in the text display.

Operating actions:

- Press the EMERGENCY STOP switch, before entering the machine.
- The malfunctions listed in the message line of the screen must be completely eliminated.
- Further actions according to chapter 07.04.

Note:

In the case of a lack of blanks, articles, article packs or pallets on the feed side, or a jam on the discharge side the machine goes into a waiting position.  
A text display (or LED display) appears on the control desk.  
The AUTOMATIC operating mode, however, remains activated, i.e. the normal sequence of movements is resumed, after the jam or the lack has been eliminated.

## 08.03. Intentional shut-down

Usually an "intentional shut-down" is required only with relatively long downtimes, not e.g. overnight. Depending on your specific requirements, an "intentional manual stop" may be enough. However, it is recommended to define a standard regulation for your entire factory.

The following operating actions are required:

- Switch off the AUTOMATIC operating mode by means of the button S1.
- If necessary, move the articles out of the machine by means of the MANUAL function.
- Turn the key-operated switch S1 to the OFF position. Remove the key and keep it in a safe place, in order to prevent an unauthorised switching-on.
- Turn off the air pressure (sliding valve on the maintenance unit).
- Turn the main switch on the control cabinet to the OFF position.

Note:

With some programmable logic controllers the program may be stored in a buffered RAM. Before switching off the main switch the function of the buffer battery should be checked according to the controller manual (LED display). If the battery is flat, the program may be erased, when the main switch is switched off.

To be on the safe side, the program should be stored on a floppy disk.

Finally the machine is to be cleaned (see chapter 09.01).

## 09.01 Cleaning

Please take note of the following when cleaning the machine.

Attention!

- Do not clean the machine with hot steam or aggressive and chlorins detergents!
- Bearing places must not be cleaned by a high-pressure cleaning device.
- Before cleaning the machine (e.g. with water) cover up all openings which - for safety and functional reasons - must be protected against liquid penetration. Special care must be taken with electric motors and switchgear cabinets.
- Before cleaning, cover up the electric fan on the electronics cabinet.
- Operator console, electronics cabinet, motors and all bearing places must not be spray cleaned with a high velocity water jet.
- Do not wash warm motors with cold water (condensation!).
- After cleaning remove all covers.
  
- Remove, using suitable safe handling methods, any broken product or other debris from the machine/conveyors.
- Generally clean the machine/conveyors both before lubricating or oiling!
- After every intensive cleaning the machine/conveyors have to be lubricated.
  
- The machine is to be cleaned with luke warm water directly after production finish (remove all remains of the production process).
  
- \* For the following work the required qualification is necessary :
  - Mechanic (for work on the mechanic)
  - Electrician (for work on the electric)
  - Operator, special qualification (work for single cases)



## 0 9 . 0 1    Cleaning (20 - hours)

!! Attention!

!! Before cleaning, control or lubrication check that the main switch on  
!! the electrical cabinet is in the "OFF" position and is secured (padlock).

The following work is to be executed by a fitter or a specially qualified machine operator:

- Debris and other foreign bodies are to be removed from the machine.
- Remains of the production process should be washed away with water regularly at the end of a shift.

Approximate time for the execution of the work :

5 minutes

## 0 9 . 0 1 Cleaning (100 - hours)

!! Attention!

- !! Before cleaning, control or lubrication check that the main switch on the electrical cabinet is in the "OFF" position and is secured (padlock).

The following work is to be executed by a fitter or a specially qualified machine operator:

- Cleaning of the complete machine/conveyors:

When cleaning the machine/conveyors treat transmitters, inductive switches, drives and bearings with care (do not directly spray with water).

After every intensive cleaning of the machine/conveyors check all lubrication points according to the instructions. If water has penetrated into the bearing, the bearing has to be lubricated.

- Light barriers and reflectors are to be dried afterwards carefully with a soft cloth and checked if the function is correct.

Approximate time for the execution of the work :

30 minutes

## 0 9 . 0 1 Cleaning (500 - hours)

!! Attention!

!! Before cleaning, control or lubrication check that the main switch on the electrical cabinet is in the "OFF" position and is secured (padlock).

The following work is to be carried out by a mechanic :

- Air filter of the electrical cabinet (blow out with air pressure)
- Clean the valve silencer (use washing petroleum!)

Approximate time for the execution of the work :

15 minutes

## 0 9 . 0 2 Check and control

!! Caution!

!! The safety devices may not be removed, be bridged, re-routed or be switched off. Everyday all safety device functions must be controlled. Specialty after reversal-, overtaking-, and repairworks on the machine or the electronics cabinet. Any breaks or damage must be instantly repaired.

\* Prior to every product change or change of shift

- check that no broken product or container debris is in the machine/conveyors.

\* For the following work the required qualification is necessary :

- Mechanic (for work on the mechanic)
- Electrician (for work on the electric)
- Operator, special qualification (work for single cases)

## 0 9 . 0 2 Check and control (20 - hours)

The following work is to be executed by a fitter or a specially qualified machine operator:

\* Check the function :

- Safety devices (trip and reset)  
e.g. light barriers, door switches, emergency stop buttons, mechanical safety latch, ...

Note:

In order to carry out this check, turn the main switch at the electrical cabinet to the ON-position.

!! Attention!

!! Make sure that no persons are inside the machine.

- Checking of signal lamps, indicators for malfunctions and EMERGENCY-STOP(lamp test)

Approximate time for the execution of the work :

10 minutes

## 0 9 . 0 2 Check and control (100 - hours)

!! Attention!

!! Before cleaning, control or lubrication the main switch on

!! the electrical cabinet has to be turned to "OFF" position and secured (padlock).

The following work is to be carried out by a mechanic :

\* Check the fixture, for damage and leaks :

- Air lines
- Lubrication lines
- Energy crocodile chain trunking
- power cable

\* Check for leak and/or oil level :

- Air maintenance unit
- Geared motors (in accordance to the manufacturer's manual).

\* Check for other mechanical defects:

- noise from the machine (eg squeaking of bearings, hammering of the chains, crashing of machine components)
- smooth running of free bearings
- wear on plastic parts

\* Control chain tension, chain has to be retightend if required

Approximate time for the execution of the work :

1 hour

## 0 9 . 0 2 Check and control (500 - hours)

!! Attention!

!! Before cleaning, control or lubrication the main switch on

!! the electrical cabinet has to be turned to "OFF" position and secured (padlock).

The following work is to be carried out by a mechanic :

\* Check the function :

- Inspection of the clutches
  
- Inspection of the motor brakes according to the manufacturer's operating manual:
  - . The brake dust is to be either blown out or vacuumed.
  - . The brake gap is to be checked (adjust if necessary).
  
- Tension, tears and pinching on pulley belts and drive chains (e.g. hoists)

## 0 9 . 0 2 Check and control (500 - hours)

The following work is to be carried out by an electrician :

\* Check the function :

- functionality and cleanliness of the toothed disk and fork light barriers
- damage on electric cables, cable conduits and controls
- check switching contacts of the brake contactors

Approximate time for the execution of the work :

1 hour



## 0 9 . 0 2 Check and control (1000 - hours)

!! Attention!

!! Before cleaning, control or lubrication the main switch on

!! the electrical cabinet has to be turned to "OFF" position and secured (padlock).

The following work is to be carried out by a mechanic :

\* Check the fixture, for damage and leaks :

- Pneumatic cylinder

\* Check for wear and tear (fitting, play in the bearing, play in the sprockets etc.):

Approximate time for the execution of the work :

15 minutes

## 0 9 . 0 2 Check and control (2000 - hours)

!! Attention!

!! Before cleaning, control or lubrication the main switch on

!! the electrical cabinet has to be turned to "OFF" position and secured (padlock).

The following work is to be carried out by a mechanic :

\* Check for wear and tear (fitting, play in the bearing, play in the sprockets etc.):

\* Check the fixture, for damage and leaks :

- Air distributor

Approximate time for the execution of the work :

1 hour

## 0 9 . 0 3 Lubrication/ greasing

- \* Prior to every lubrication activity, the main supply switch on the operator console must be turned OFF and secured (padlock).

Note:

This does not apply to lubrication points for which central lubrication is provided.

- \* Use only the KRONES recommended lubricants (lubrication chart !).
- \* Lubrication and oil replenishment of the drive motors must be done to the manufacturers specification.
- \* Generally clean the machine both before lubricating or oiling !

!! Attention !

!! Do not mix different synthetic lubricants and do not mix them with mineral lubricants.

!! When using synthetic lubricants there is a warning sign on the gearbox.

!! Attention!

!! Due to difficult operation conditions; high humidity, dust or aggressive environment or even high temperature changes it is recommended to shorten the change intervals!

Symbols used for the lubrication charts:

- Circle with number or letter = single lubrication point
- Rectangle with number = lubrication block

The lubrications points with a "single" number have been put together to a lubrication block.

- "Single" number

Instruction as to which position belongs to the lubrication block to be lubricated.

## 0 9 . 0 3 Lubrication/ greasing

\* Caution!

When a grease central lubrication unit is present, refill with multipurpose grease. The following lubrication chart and the specifications of the grease pump manufacturer should be used as guidelines. It is recommended to use only lubricants of the same brand.

Note!

If individual KRONES machines are to be combined with a customer's centralized lubricating system, intervals and scheduled times for lubrication are to be set according to the specifications of KRONES'S engineering department.

\* Note for the lubrication chart :

- The listed lubrications are not compatible with food stuffs.













\* Note for the lubrication points:

All bearings without lubrication connection are lubricated for life.

## Lubrication-chart (1/2) N

For the lubrication of our machines we recommend the lubricants shown in the lubrication chart or similar equivalent lubricants of other suppliers.

Attention! The following listed lubricants are not compatible with food stuffs.

	0	1	2	3	4
Lubricant		Lubrication oil	Lubrication oil	Static friction oil	Gear box oil
Example for application		Mist unit Hydro pneumatic	General Lubrication points	Chains, Racks, Adjusting gear boxes	Gear box motors, not worm geared motors
Symbol according to DIN51502					
Ambient temperature oil-/grease temperature area		- 20... + 60 C	- 20... + 60 C	- 20... + 60 C	0... + 40 C - 15... + 25 C
Oil viscosity (DIN 51 519) Grease consistence (DIN 51 818)		ISO - VG 22... 32 de-emulgating	ISO - VG 46	ISO - VG 220 with EP additives	ISO-VG220/VG 150
Minimum requirement according to		DIN 51 524, part 1 - HL	DIN 51 517, part 2 - CL	good friction water resistant	DIN 51 517, part 3 - CLP
		Vitam DE 22	Vitam GF 46	Deganit B 220	Degol BG 220 / Degol BG 150
		Energol HLP-D 22	Energol HLP-HM 46	Energol GR-XP220	*)Energol GR-XP220 Energol GR-XP100
		Hyspin AWS 22/32 Hyspin SP 22/32	Hyspin AWS 46 Hyspin SP 46	Magnaglide D 220	Alpha SP 220/150 Alpha MW 220/150
		Astron HL 22, 32 DEA Eterna 32	Astron HL 46 DEA Eterna 46	Novan CGLP 220	Falcon CLP 220/150 Trion EP 220/150
		Nuto H 22	Teresso 46	Millcot K 220 (Perma SO 04)	Spartan EP 220 Spartan EP 150
		AIRPRESS 32	LAMORA HLP 46 CRUCOLAN 46	+) Structovis EHD	Klüberoil GEM 1 - 220, ... 150
		Mobil DTE 22 Mobil DTE 24	Vactra Oil Medium	Vactra Oil Nr. 4	Mobilgear 630 Mobilgear 629
		Hydo 22 Ultra PR	Hydo 46 Ultra 46	Viscogen KL 23	Ultra 220 Optigear 220
		Shell Morlina 22	Shell Vitrea 46	Shell Tonna T 220	*) Shell Omala 220 Shell Omala 150
		Azolla 22	Azolla 46	Carter EP 200	Carter EP 220 Carter EP 150
		Wiolan CD 22	Wiolan CD 46	Wiolan TH 220	*) Ersolan 220 *) Ersolan 100, 150
	Zeller + Gmelin	+) Divinol DHG 22	+) Divinol DHG 46	Divinol T 12 EP220	Divinol ICL 220 Divinol ICL 150

+) KRONESstandard used lubricants.













\*) SEW standard used lubricants.

Attention! Synthetic lubricants are not to be mixed neither with mineral lubricants.

## Lubrication-chart (2/2) N

For the lubrication of our machines we recommend the lubricants shown in the lubrication chart or similar equivalent lubricants of other suppliers.

Attention! The following listed lubricants are not compatible with food stuffs.

Lubricant	0	5	6	7	8
	Gear box oil	Compressor oil	Multi purpose oil	Liquid grease	
Example for application	Worm geared motors	Vacuum pumps	Central lubric. systems General lubric. points		
Symbol according to DIN51502					
Ambient temperature oil-/grease temperature area	0... + 40 C	> = + 10 C	- 20... + 120 C	ISO VG 150 NLGI 00 ... 000	
Oil viscosity (DIN 51 519) Grease consistence (DIN 51 818)	ISO - VG 680	ISO - VG 100	NLGI 2	NLGI 00 ... 000	
Minimum requirement according to	DIN 51 517, part 3 - CLP	DIN 51 506 - VC	DIN 51 825 - KP2K - 20	DIN 51 826 - GP 00/000 G-20	
	Degol BG 680	Kowal M 30	Aralub HLP 2	Aralub MFL 00	1
	Energol GR-XP680	Energol RC 100	Energrease LS - EP 2	Energrease LS - EP 00	2
		Aircol PD 100	Spheerol AP 2	CLS - Grease	3
	Falcon CLP 680	Actro EP VDL 100	Glissando EP 2 Paragon EP 2	Glissando 6833 EP 00	4
	Spartan EP 680	Nuray 100	Beacon EP 2	GREASE TCL 435	5
	Klüberoil GEM 1 680	CRUCOLAN 100	+) CENTOPLEX 2 EP	CENTOPLEX GLP 500 (Li)	6
	*) Mobilgear 636	Vacuum pump oil heavy	*) Mobilux EP 2 (gear box)	Mobilux EP 004 (GP 00 G-20)	7
	Optigear BM 680	Copo 100	Olit 2 EP Olit CLS	+) Olit CLS 000	8
	*) Shell Omala 680	V - Oil 9930 Shell Talpa oil G 100	*) Alvania R3 (Mot), R2 (Masch)		9
		Cortis 100	Multis EP 2	Multis EP 200 Liquid grease ZS 00	A
	Ersolan 680	Wiolan CD 100	Wiolub LFP 2		B
	Divinol ICL 680	+) Divinol VDL 100	Divinol Fibrous 2	Divinol grease Central (Li)	C

+) KRONESstandard used lubricants.

\*) SEW standard used lubricants.

Attention! Synthetic lubricants are not to be mixed neither with mineral lubricants.

## 09.03 Lubrication/ greasing (20 - hours)

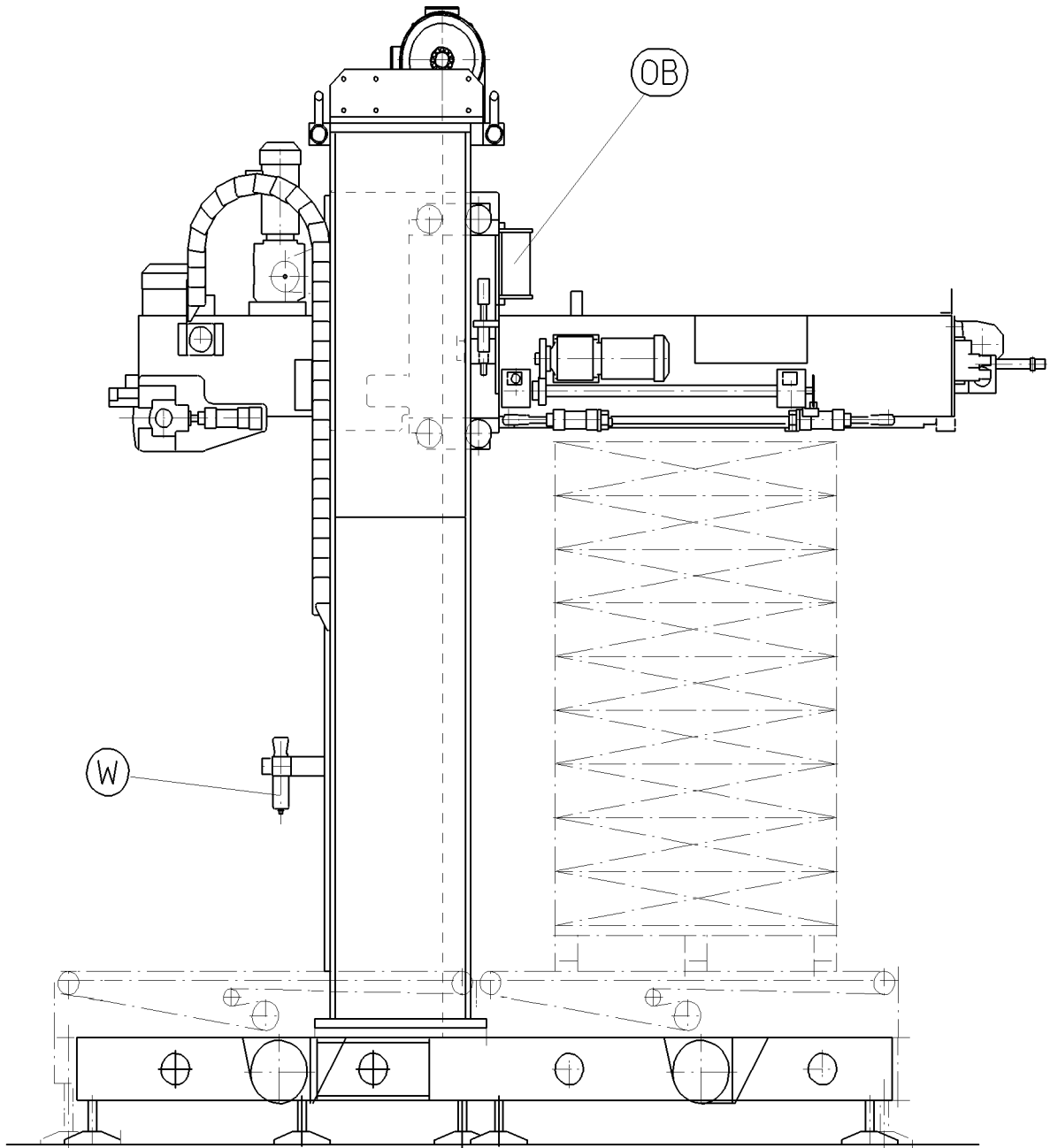

S1368005.20

## 0 9 . 0 3 Lubrication/ greasing (20 - hours)

!! Attention!

!! Before cleaning, control or lubrication the main switch on

!! the electrical cabinet must be in the "OFF" position and secured (padlock).

The following work is to be carried out by a mechanic :

- Fill up with hydraulic oil: according to the lubrication chart

W : Air maintenance unit

With shut off valve (maintanance unit) deventilate the machine.

Release condensed water if the machine does not have an automatic valve.

If the machine has oil lubrication: Check oil level and top up if necessary.

OB : Oil tank for hydro pneumatic chain tensioner

Check the oil level and if necessary refill.

(Check by means of tank sight glass)

Approximate time for the execution of the work :

5 minutes



## 09.03 Lubrication/ greasing (100 - hours)

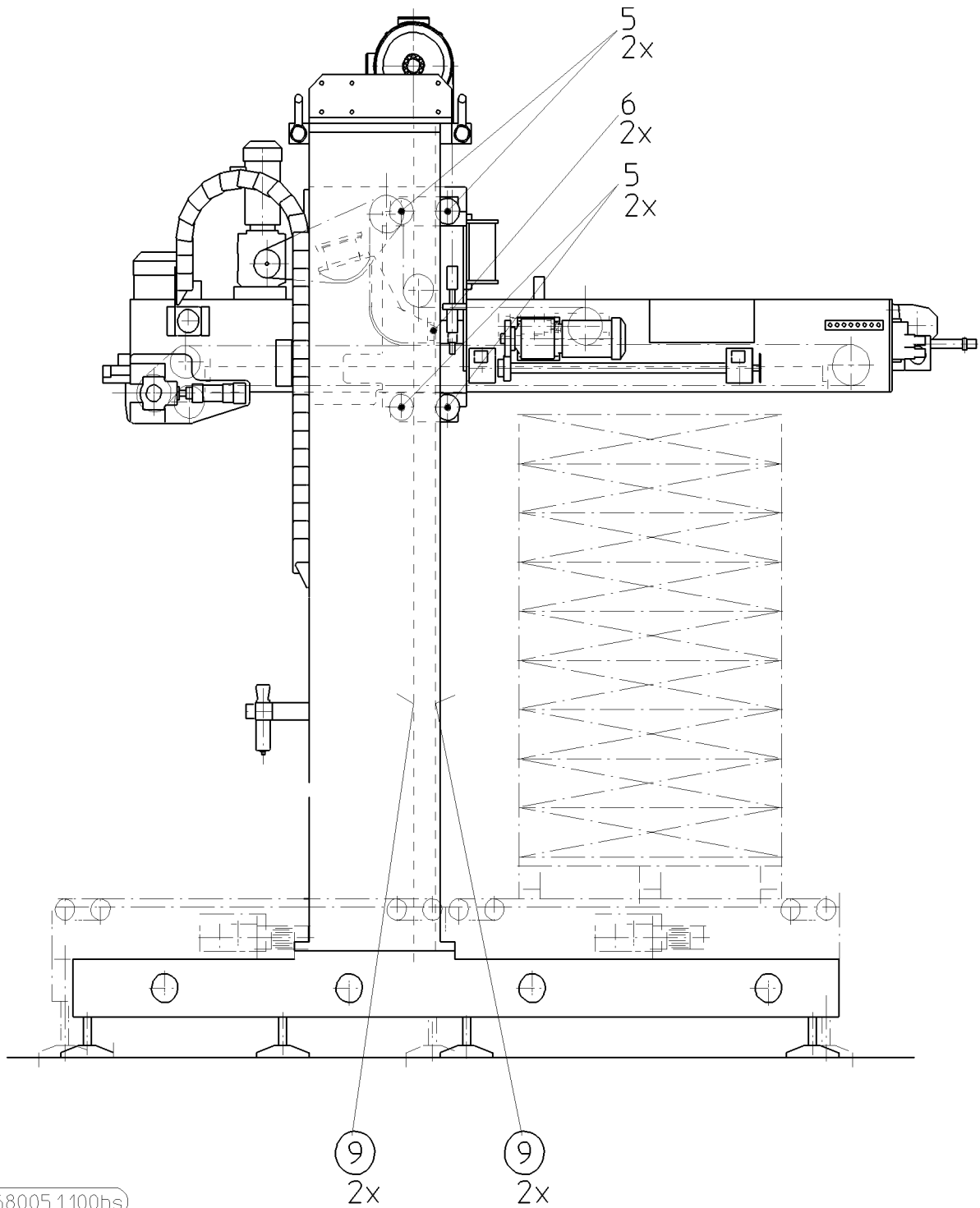

Operating instructions

Palletizer PRESSANTUNIVERSAL1N

KR51-373



## 09.03 Lubrication/ greasing (100 - hours)

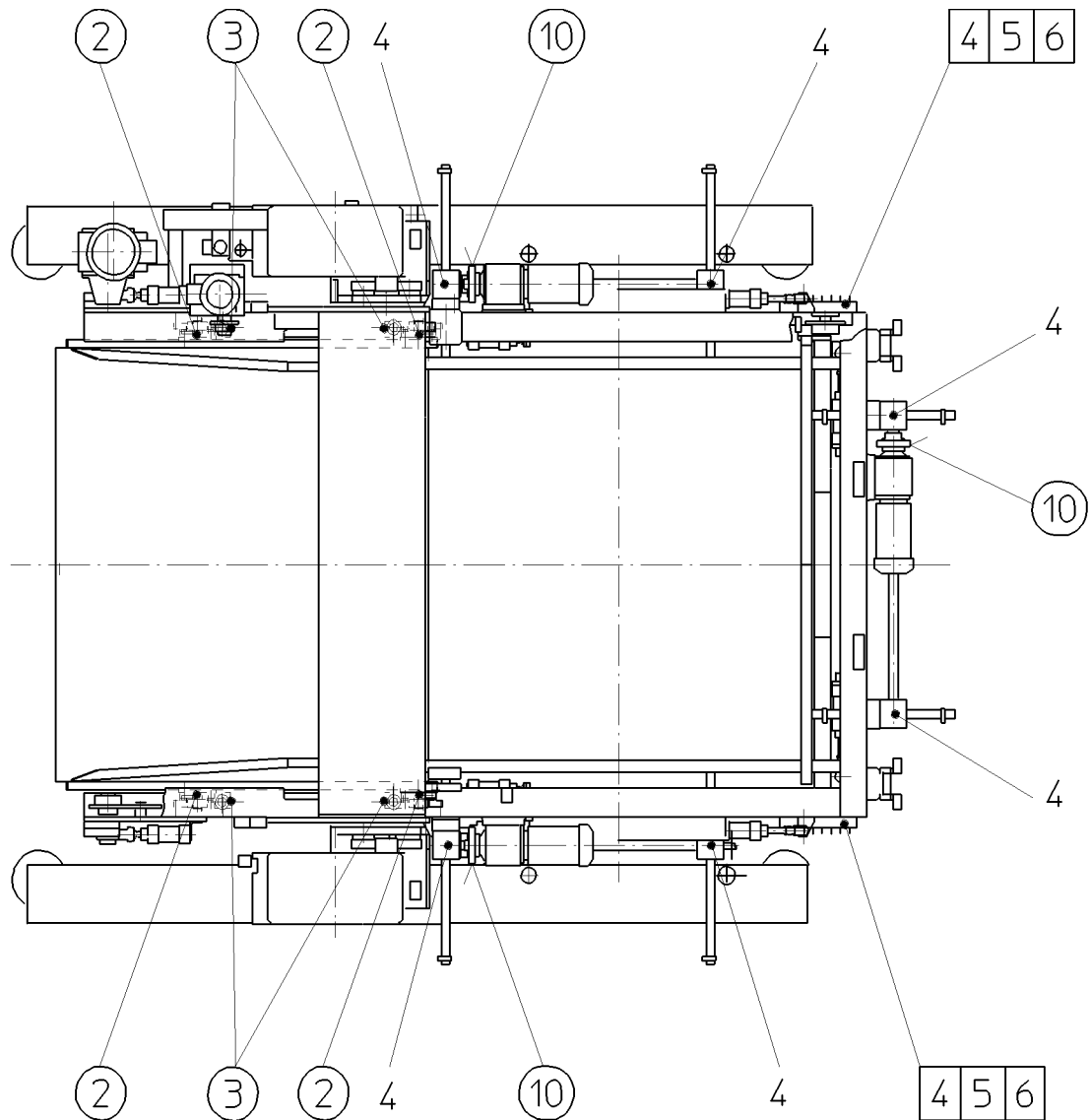

S1368005 2.100bs

Operating instructions  
Palletizer PRESSANTUNIVERSAL1N  
KR51-373



## 09.03 Lubrication/ greasing (100 - hours)

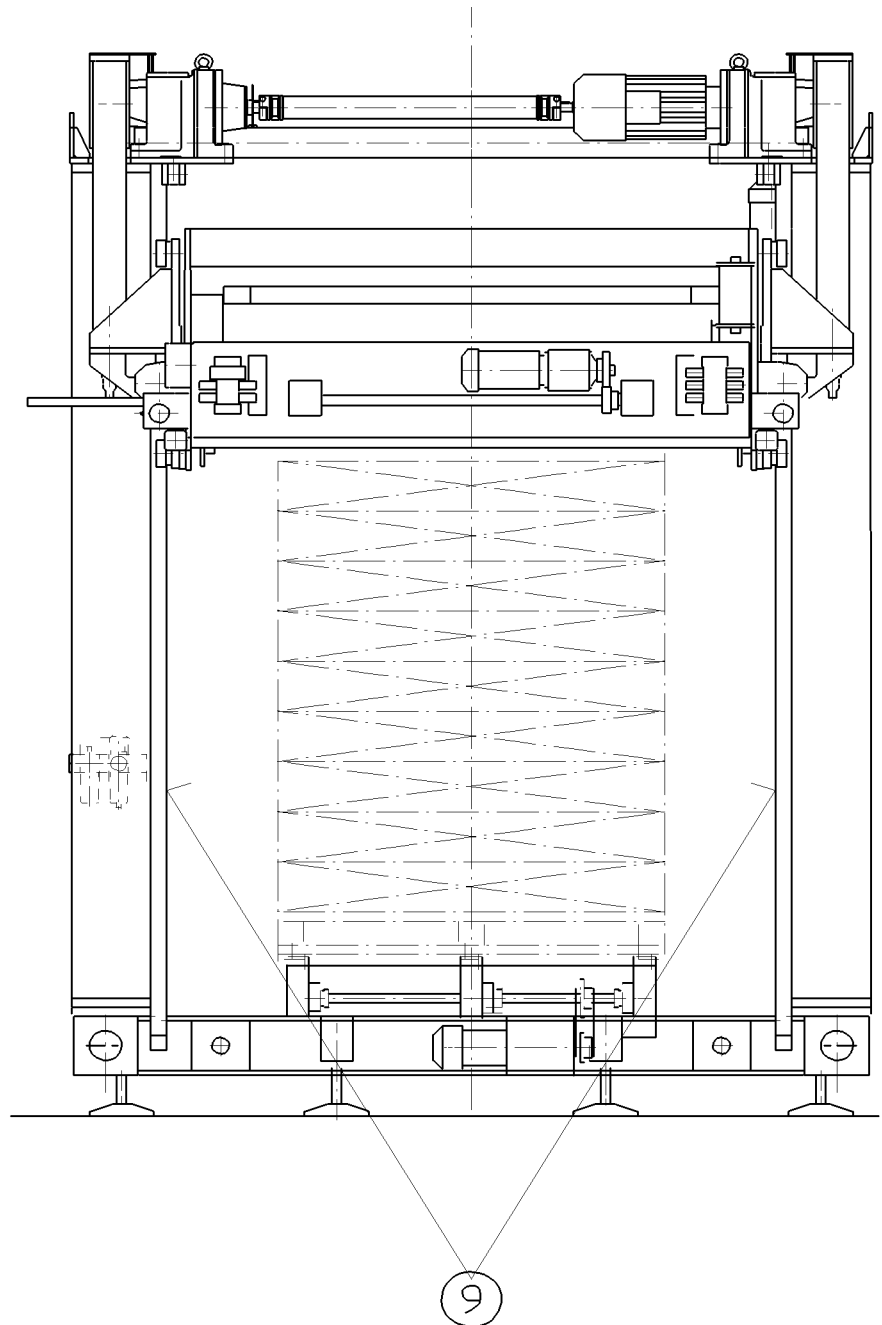

S1368005.3.100

Operating instructions  
Palletizer PRESSANTUNIVERSAL1N  
KR51-373



## 0 9 . 0 3 Lubrication/ greasing (100 - hours)

!! Attention!

!! Before cleaning, control or lubrication the main switch on

!! the electrical cabinet must be in the "OFF" position and secured (padlock).

The following work is to be carried out by a mechanic :

- Lubrication with multiple purpose grease according to the lubrication chart:

4 : gearbox housing for power driven guide adjustment (custom-built)

2 lubrication points per guide adjustment

5 : curve rollers of hoist

8 lubrication points (4 x right-hand, 4 x left-hand)

6 : supporting rollers of hoist

2 lubrication points (1 x right-hand, 1 x left-hand)

9 : guide rails

(lubricate with a brush at machine stop)

10 : pair of spur gears of motor-driven guide adjustment

Lubricate with a brush !

Approximate time for the execution of the work :

30 minutes

## 09.03 Lubrication/ greasing (100 - hours)

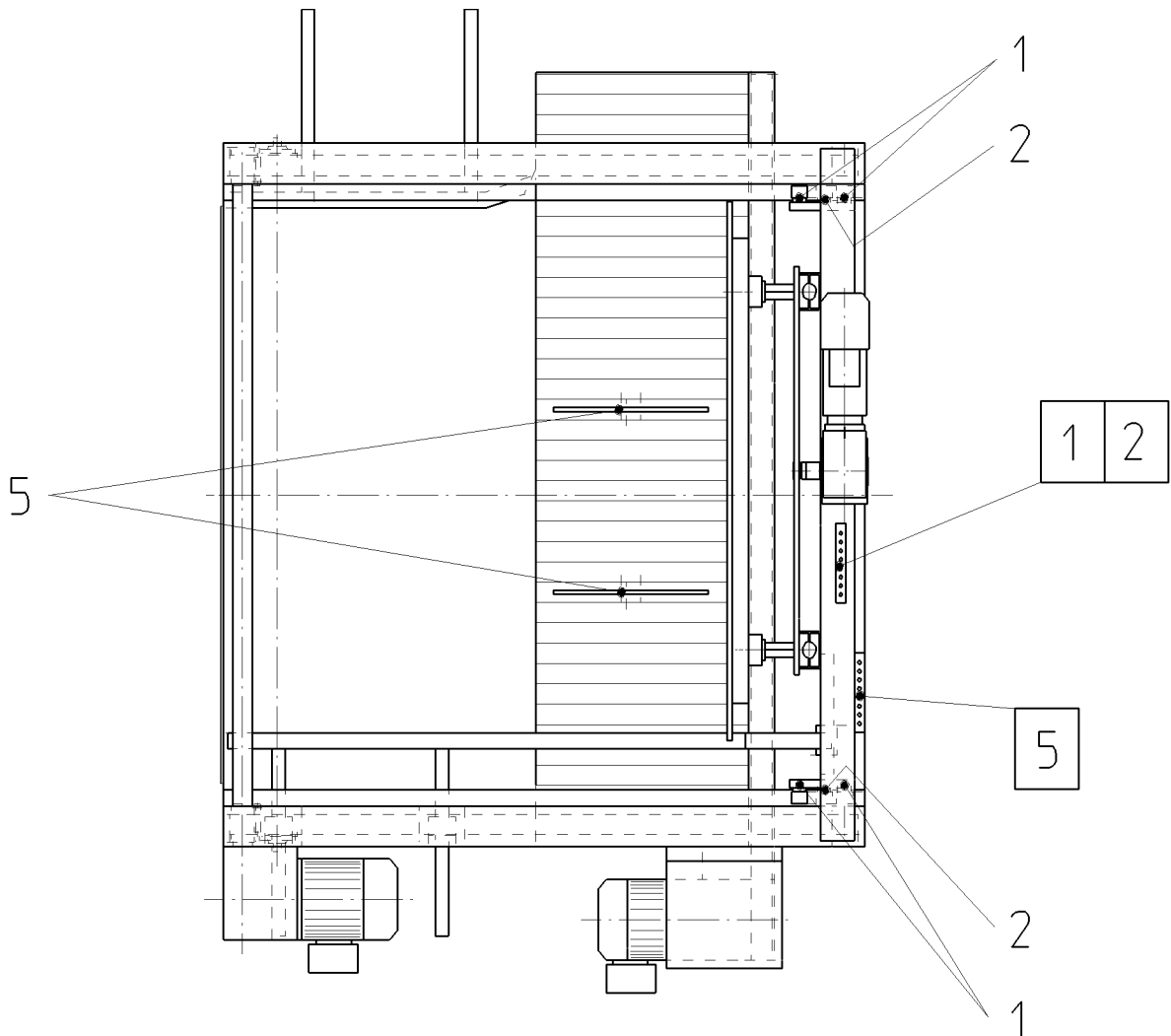

S13703.100bs

## 0 9 . 0 3 Lubrication/ greasing (100 - hours)

!! Attention!

!! Before cleaning, control or lubrication the main switch on

!! the electrical cabinet must be in the "OFF" position and secured (padlock).

The following work is to be carried out by a mechanic :

- Lubrication with multiple purpose grease according to the lubrication chart:

Row pusher (custom-built):

1 : curve rollers

4 lubrication points (2 x left-hand, 2 x right-hand)

2 : supporting rollers

2 lubrication points (1 x left-hand, 1 x right-hand)

5 : guide bush for spacer plate (custom-built)

1 lubrication point per spacer plate

Approximate time for the execution of the work :

15 minutes

## 09.03 Lubrication/ greasing (4000 - hours)

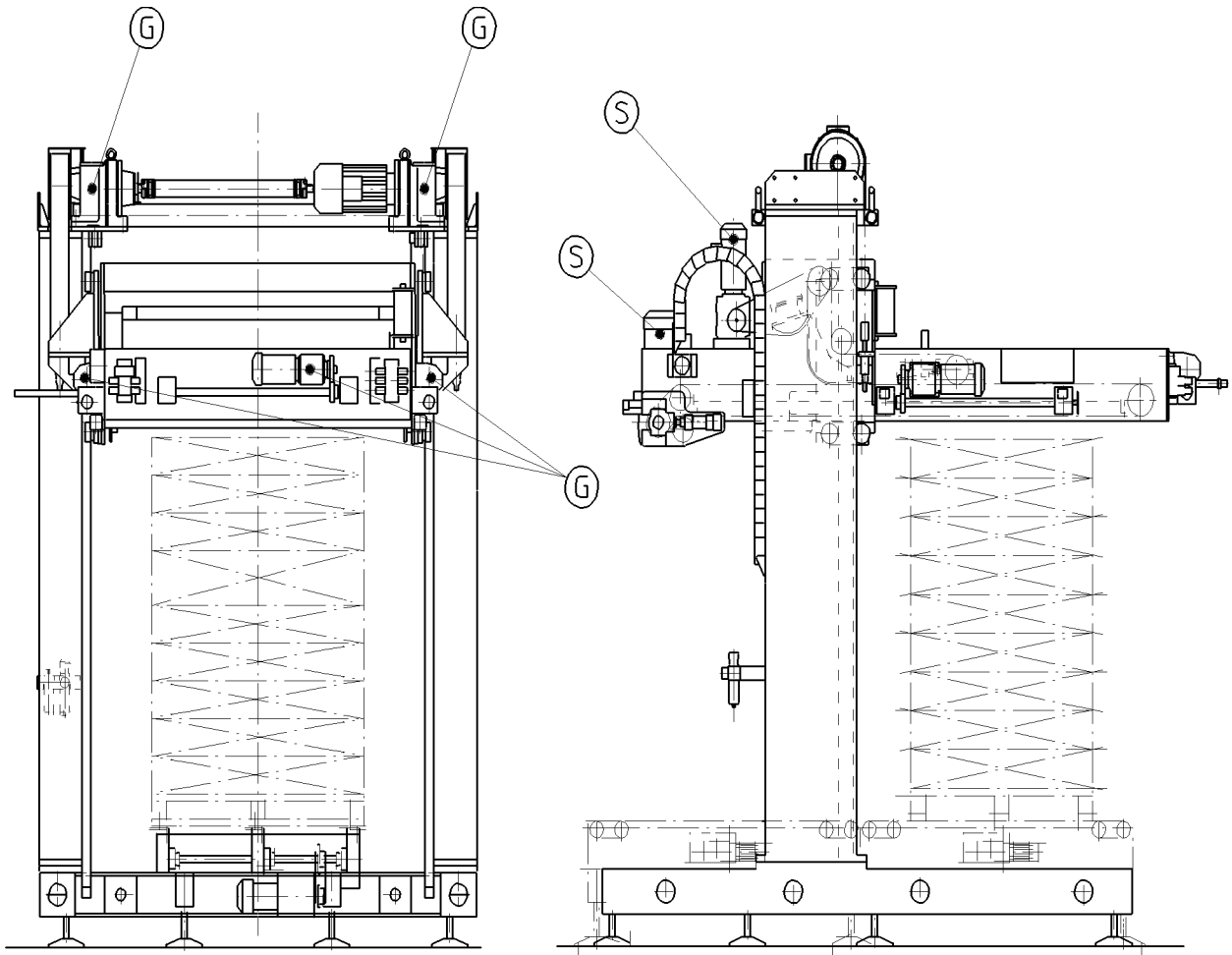

S1368005 4000

## 09.03 Lubrication/ greasing (4000 - hours)

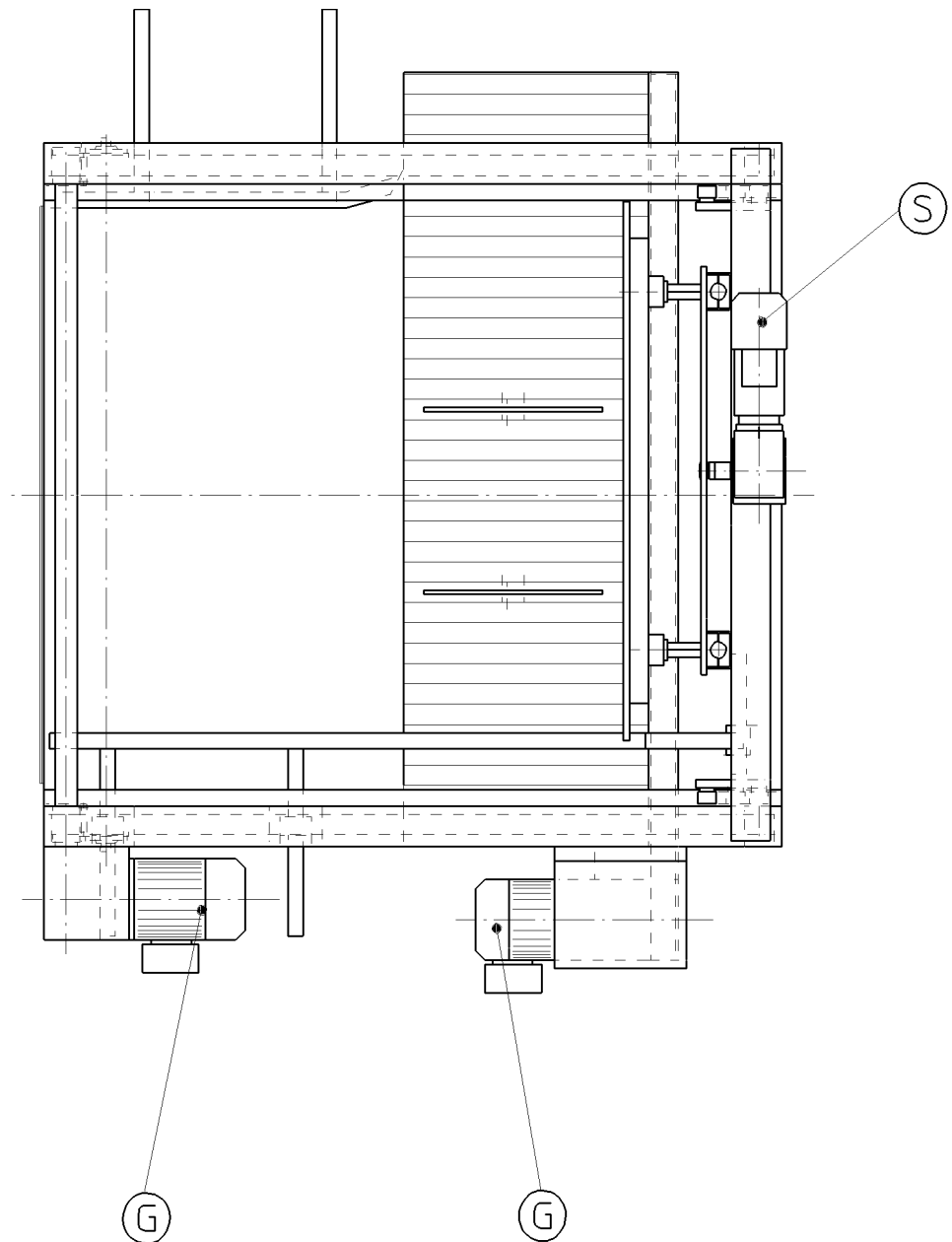

S13703.4000



## 0 9 . 0 3 Lubrication/ greasing (4000 - hours)

!! Attention !

!! Do not mix different synthetic lubricants and do not mix them with mineral lubricants.

!! When using synthetic lubricants there is a warning sign on the gearbox.

- Check and, if necessary, lubricate according to the lubrication chart. Maintenance is carried out according to the motor manufacturer's operating manual.

G : Geared motor (not worm geared motor) or gear box

S : Worm geared motor or worm gear

SG : Servo motor (d.c. motor) with mounted gear box

FM : Flange motor with mounted gear box

Precise model type, see name plate or spares lists.

- \* On gear motors check lubrication level.

Approximate time for the execution of the work :

for each motor or gear box about 15 minutes

## 09.04 Specialtools

- !! Attention !
- !! No devices, which are not delivered by KRONES must be installed
- !! at the machine without approval of KRONES.

For the machine/conveyors no special tools are necessary.

## 09.05 Preventativemaintenance

- !! Attention !
- !! After completion of any mechanical or electrical work, please make sure
- !! that all safety devices provided are again in full working order.
  
- \* Any damaged or worn parts must be exchanged at once, before they cause any costly machine breakdown.
- \* Required installation procedures for the drive motors according to the manufacturer's recommendations.
  
- \* Tighten all screw connections of the moving parts every 1000 hours.

## 0 9 . 0 6 Maintenance

!! Attention !

!! The access to the electric cabinet is only permitted to licenced staff.

!! After completion of any machanical or electrical work, please make sure

!! that all safety devices provided are again in full working order.

Minor repairs of a mechanical nature that do not interfere with the safety may be carried out by the machine operators, as long as these are adequately trained to execute the repairs according to the usual standards.

KRONES takes no responsibility for faults and damage to the product, arising out of these repairs.

Work which is only to be carried out by KRONES trained personnel:

- \* Repairs to the machine hoist (when available).
- \* Changes to the basic machine set-up.

## 09.06 Maintenance

\* Hydro-pneumatical chain tensioner

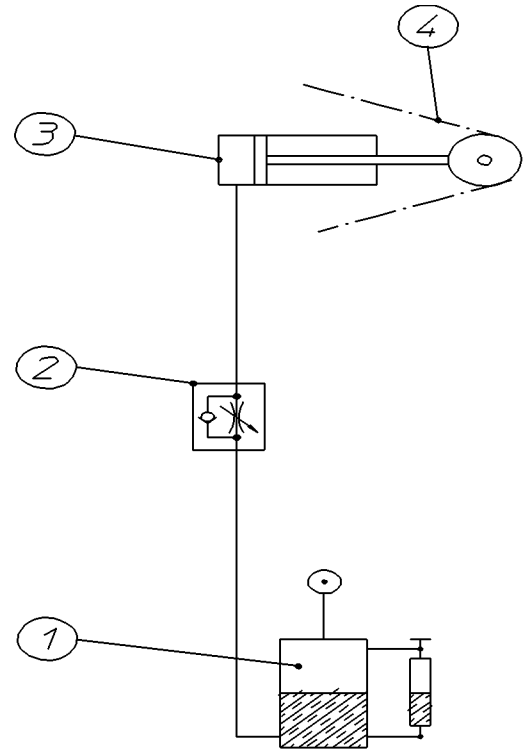

11000-3191

- 1 = Compensation tank
- 2 = No-return-valve
- 3 = Cylinder
- 4 = Chain

## 0 9 . 0 6 Maintenance

\* Description of the hydro-pneumatical chain tensioner:

The chain (4) is tensioned by a hydro-pneumatic activated cylinder (3).  
In order to remove the chain the cylinder must be relieved.

- The operation pressure (5 bar) is fed into the half-full with oil compensation tank (1).  
The cylinder and its connection hoses to the compensation tank are also filled with oil.
- The no-return-valve (2) prevents pressure release of the cylinder when the chain is loaded. Therefore the chain remains tensioned.  
The no-return-valve is either fixed to the compensation tank or to the cylinder.
- To relieve the chain pressure the operation pressure on the compensation tank and the valve on the no-return-valve must be opened.

!! Attention !

!! By too high or too low operation pressure the chains and the sprockets  
!! can be damaged.

Hydraulic-oil according to the lubrication chart.

## 0 9 . 0 7 Instructions for spare and wear parts

Replacement and wear and tear parts for this machine as per the spare parts list can be supplied (a component part relating to the complete machine).

You are to use only original KRONES wearing parts and KRONES replacement parts. Failure to do so will invalidate all claims in connection with the warranty, accommodating arrangements or any other contractual agreements.

## 1 0 . 0 1 Generalinstructions

!! Caution!

!! Do not reach into or enter the machine, while it is operating.

- \* Any fault-finding activities on the machine should only commence once the EMERGENCY- STOP pushbutton has been depressed.
- \* The basic procedure to follow when faults occur, is to check:
  - Correct machine programme and layer/stack selection.
  - Correct functioning of the limit, proximity and light sensors.
  - That undamaged and correctly selected product is being run through the machine (articles, cases, pallets, fold-cartons).

If there are faults, these appear in the upper message line of the display on the operating panel.

Additionally the indicating light "fault" is illuminated on the operating panel.

After a failure has been eliminated, the following operating actions must always be carried out:

- reset the EMERGENCYSTOP button S10, close guard doors
- acknowledge the safety zone
- press reset button S6
- select operating mode AUTOMATIC with key S4
- start operating mode AUTOMATIC with key S2

Thus, the machine is in AUTOMATIC mode.

!! Warning!

!! Faults of the electrical and mechanical part of the machine are to be eliminated by qualified and skilled personnel only.

## 1 0 . 0 2 Faultfinding

A further selection of fault causes are as follows:

Fault cause : The containers do not feed into the machine.

Fault-finding:

- The relevant light barriers may be dirty. It can be seen if the light barriers are working correctly, when the LED indicator on them changes as the containers pass. If necessary, clean the sensors.
- The container guide track rails may not be correctly set-up; check these are set to the marked position, also check the spacing on each side of the container (5 mm).
- Check the transport rollers of the grouping station: Worn-out rollers are to be exchanged or the drive belt is to be adjusted.

Fault cause : Incorrect infeed of containers into the machine.

Fault-finding:

- The light barrier is dirty.  
Effective control: In case of a dirty light barrier the LED display changes.
- If the rubber infeed rollers are worn-out they must be exchanged with new ones.
- If the belt on the feed conveyor is worn-out it must be replaced by a new one.
- If the belt on the feed conveyor slips, it must be tightened.

Fault cause : Jamming of the containers.

Fault-finding:

- Remove the containers which are jamming in the machine and that do not meet the desired standards.
- Check that the container guide track rails are set to their correct positions.
- Should the container dimensions have changed outside the current limits set on the machine, then the basic set-up of the machine needs to be changed by authorised KRONES personnel.



## 1 0 . 0 2    Faultfinding

Fault cause : No empty pallet infeed or full pallet discharge.

Fault-finding:

- Sort out the damaged pallets; overhanging pallet boards can cause jams on the pallet guide rails.
- Check the positioning light barriers accordingly (LED display) and adjust if necessary.

Fault cause : Excess wear and tear or loose chains on the drive of the loading plate.

Fault-finding:

- Check the oil level on the oil tank for the hydro-pneumatic chain tensioner, if necessary refill with oil.

Fault cause : Incorrect vertical positioning of the hoist.

Fault finding:

- Check hoist motor brake for functioning (brakes eventually wear out).
- Check relevant light barriers.
- Check if the induction sensor for position measurement is defective.
- Check the position and brackets of the induction switches for hoist stop.

Fault cause : The loading carriage does not deposit the containers correctly.

Fault-finding:

- When badly shaped containers are being handled they must be sorted out.
- When the rails of the centring have not been set correctly (not according to the given layer dimension) they must be set according to the mark.  
With automatic guide adjustment the alteration of the software has to be carried out by a KRONESengineer.
- When the depositing height of the containers is too high the light barrier for "hoist slow" and "hoist stop" must be adjusted.  
Check the function of the fork type light barrier "hoist travel register" (positioning light barrier).

## 1 0 . 0 2 Faultfinding

Fault cause : Power supply is interrupted (eg power failure)

Fault-finding:

If power supply made on again:

- Acknowledge malfunction message and reset fault display at control desk.
- Operate the machine in HAND operation mode until it is empty.
- Change over to AUTOMATIC operation mode.

## 1 1 . 0 1 General regulations

- \* Apparatus Safety Legislation (GSG - 1. 1. 1993)
- \* Product Liability Legislation (1. 1. 1990)
- \* DIN EN 60204 (VDE 0113)
- \* Instructions for packaging machines of the board of Food Stuffs Industry
- \* Statements in operating instructions (DIN V 8418)
- \* Manipulating industrial robots; safety, DIN EN 775, date of issue 08.93

## 1 1 . 0 2 Important instructions for the user

To assist the operator of the machine in his daily tasks, the following should be noted:

- \* Observe all company rules.
- \* A regular check (book) of the safety devices is to be carried out.
- \* Operation of machines and plant as well as installation work is to be carried out only by personnel who are authorised, trained, thoroughly instructed and suitable.
- \* If work has to be carried out on live parts, a second person has to be present who can switch off the main switch, if necessary.
- \* For machine change-over, maintenance such as cleaning, tests and checks, lubrication / oiling the following should be adhered to:
  - EMERGENCY-OFF switch to be activated
  - Main switch (control cabinet) to be turned to OFF and to be secured with a lock-out.
- \* During installation work, the machine may only be activated MANUALLY (inching).
- \* Safety characteristics to be noted (colour, marks according to ISO-DIN 3864).
- \* An orderly maintenance sequence must be maintained.
- \* Work hygiene to be observed together with first aid facilities.

!! Caution!

!! Faults which may cause dangers have to be eliminated immediately.

!! Do not reach into or enter the machine, while it is operating.

## 1 1 . 0 2 Important instructions for the user

Note:

As a rule, our "General Terms of Sale and Delivery" have to be applied.

No liability will be assumed for injury or property damage caused by one or several of the following conditions:

- \* Inadequate or improper installation, commissioning, operation and maintenance of the machine/system.
- \* Operating the machine/system with defective safety devices or with improperly or inadequately mounted or disabled safety and protection devices.
- \* Never make any modifications, additions or conversions which might affect safety, or alterations in the control concept (hard- and software) without the supplier's written approval.  
This also applies to the installation and adjustment of safety devices and valves as well as to welding work on load-bearing elements.
- \* In case of necessary work below the loading station or below the hoist it is absolutely necessary before to lower both safety levers of the hoist support and then drive down the loading station to the adjusted level of the safety levers.
- \* Please observe the leaflets of the suppliers of equipment and functional components!  
(see section 13.02)

## 1 1 . 0 3 Safeguards

!! Caution!

!! Safety devices, may not, at any time, be made inoperable.

!! Any breaks or damage must be reported immediately.

!! Working on the machine has to be stopped until the repairs have been

!! carried out.

\* Safety devices for operators:

- EMERGENCYSTOPBUTTON  
on the operator console, adjacent to the machine and danger areas (see section 08.02)
- Safety light barriers  
are installed on the machine framework and entrances to the danger area to control possible access to the working parts of the machine whilst it is running.  
Effective in the same way as the EMERGENCYSTOP!
- Bolted guard fences, guard doors and/or locked safety devices like guard fences, guard plates, transparent safety devices (e.g. provided with acrylic glass)
- Resetting Switch  
which has to be reset after leaving the danger area.

## 1 1 . 0 3 Safeguards

\* Devices for machine protection:

These devices have been constructed to switch off the machine in order to protect it against overload, malfunctions and processing goods in unworkable sizes. According displays will be shown at the console.

- Pressure control device (entire machine)  
The pressure of the air supply is checked by means of a pressure control device.  
In case the actual pressure falls below the set minimum value (app. 4.5 bar pressure above atmospheric), the machine will be stopped.
- Protective motor switch  
The load of motors is controlled by protective motor switches.  
With frequency regulated motors or motors with a high switching frequency, the admissible coil winding temperature is controlled via sensors in the coil winding.
- Operation stop switch  
Most machine motions are additionally secured by means of an operation stop switch or a software stop switch behind the normal stop switch. When the machine reaches such a switch, it is stopped immediately.
- Control (SPS/PLC)  
Fault signals are displayed on the control desk.

## 1 2 . 0 1 Customer advice

A well-trained staff in the company and in the field service, sales offices and branch works as well as numerous foreign representatives are always available to our customers and persons interested in our products.

Please send your enquiries to:

KRONESAG

Äußere Münchener Straße 104  
D - 83026 Rosenheim

Telephone (08031) 404 0  
Telefax (08031) 404 298



## 1 2 . 0 2    Technicalservice

The service department of the Rosenheim work can be addressed by contacting:

KRONESAG  
Werk Rosenheim

Kundendienst

Äußere Münchner Straße 104  
D - 83026 Rosenheim

Telephone (0 80 31) 404 0  
Telefax     (0 80 31) 404 169

When contacting the customer service, the following details have to be given:

- customer's company name
- customer's address
- customer's representative for a special problem
- machine type
- commission no. ( K Rxx-xxx)

When experiencing problems with the electronics, contact our electronics' fault service and indicate:

Electronics plan no. ( KRxxxxx-xxx)

During the discussion the valid electronics plan (motor plan, programme plan) should be at hand!

## 1 2 . 0 3 Spares service

The spare parts service of the Rosenheim work can be reached by addressing:

KRONESAG  
Werk Rosenheim

Ersatzteildienst

Äußere Münchner Straße 104  
D - 83026 Rosenheim

Tel. (08031) 404 0  
Fax (08031) 404 149

The KRONES authorised Works-Branches or Overseas-Agencies also have a Spare Parts Service.

Attention!

In order that you receive your ordered parts swiftly, we kindly request that you state the following type of delivery :

\* Required type of delivery

Mail  
Express mail  
Ordinary freight  
Express goods  
Air mail  
Air freight

\* Precise delivery address : Post or Railstation

---

Operating instructions  
Palletizer PRESSANTUNIVERSAL1N  
KR51-373



## 1 2 . 0 4 Training

Customer training courses are offered at our Rosenheim works and at the customer's works.

For inquiries please address the KRONESAcademy in Neutraubling. You will also find further informations at [www.krones.com](http://www.krones.com).

## 1 3 . 0 1 Customer specific specialfunctions

Customer specific special functions have been accounted for in these operating instructions.

## 1 3 . 0 2 Instructional pamphlet of suppliers

For the equipment or functional units supplied to KRONES by other manufacturers, which are installed in this machine only their Leaflets, Catalogues, Operating Instructions, Tables or Descriptions are valid, e.g:

- Drives : SEW
- Pneumatic air maintenance unit : BOSCH
- Hot melt or cold glue unit : NORDSONCORPORATION
- Lubricator : SOHM
- Vacuum pumps : BUSCH
- Control units : LEUZE (in the electrical cabinet)
- Electronic cam switching unit : DEUTSCHMANN  
(in the electrical cabinet)
- Slip clutch : MORSE

The above are supplied with the KRONES spare parts lists or, as the case may be, are available in the electrical cabinet.

!! Attention !

!! In particular, the Safety Notes and Maintenance Instructions contained in  
!! these should be observed.

## 1 3 . 0 3 Suitable operation and auxiliary materials

Types of lubrication : refer to lubrication chart chapter 09.03.

--- End of instruction manual ---

**Germany**

KRONES AG  
Böhmerwaldstraße 5  
93073 Neutraubling  
Deutschland  
Tel. +49 9401 70-0  
Fax +49 9401 70-2488  
http://www.krones.com  
E-mail: info@krones.com

KRONES AG  
Verkaufsbüro Nord-West  
Hausinger Straße 8  
40764 Langenfeld  
Deutschland  
Tel. +49 2173 903-802  
Fax +49 2173 14290  
E-mail: nord.west@krones.com

**Albania**

KRONES Representative Office  
Rr. "Vaso Pasha", Ap. No. 8  
Tirana  
Tel. +355 42 254944  
Fax +355 42 254944

**Argentina**

KRONES SURLATINA S. A.  
Riobamba 588, Piso 1°  
1025 Buenos Aires  
Tel. +54 11 43732884  
Fax +54 11 43729612  
E-mail: ventas@krones.com.ar

**Belgium**

S.A. KRONES N.V.  
Parc Scientifique Einstein  
Rue du Bosquet, n° 17  
1348 Louvain-la-Neuve – Sud  
Tel. +32 10 480700  
Fax +32 10 480722  
E-mail: krones@krones.be

**Brazil**

KRONES DO BRASIL LTDA.  
Av. Presidente Juscelino, 1140  
(Piraporinha)  
09950-370 Diadema, São Paulo  
Tel. +55 11 40759500  
Fax +55 11 40759800  
http://www.krones.com.br  
E-mail: vendas@krones.com.br

**Bulgaria**

KRONES Representative Office  
Zlaten rog Str. 20 - 22,  
Etage 4 / Lozenez  
1407 Sofia  
Tel. +359 2 862 490  
Fax +359 2 862 5306  
E-mail: repr\_krones@krones.net

**Canada**

KRONES MACHINERY CO.  
LTD.  
28 Regan Road  
Brampton, Ont. L7A 1A7  
Tel. +1 905 840-50 00  
Fax +1 905 840-29 00  
E-mail:  
kathryn.nichols@kronesusa.com

**Colombia**

KRONES ANDINA LTDA.  
Av. Calle 80 No. 69-70  
Local 30  
Santafé de Bogotá, D.C.  
Tel. +57 1 3108808  
Fax +57 1 3108798  
E-mail:  
krones-andina@krones.com.co

**Czech Republic**

KRONES s.r.o.  
Nádražní 86  
150 00 Praha 5  
Tel. +420 2 57315663  
Fax +420 2 57315662  
E-mail: krones@krones.cz

**Denmark**

KRONES NORDIC ApS  
Skovlytoften 33  
2840 Holte  
Tel. +45 88 323300  
Fax +45 88 323301  
E-mail: krones@krones.dk

**France**

KRONES SARL  
Tour Société Suisse  
1, Boulevard Vivier Merle  
69443 Lyon Cedex 03  
Tel. +33 472 114191  
Fax +33 472 114196  
E-mail: krones@krones.fr

**Great Britain**

KRONES UK LTD.  
Westregren House  
Great Bank Road  
Wingates Industrial Park  
Westhoughton  
Bolton BL5 3XB  
Tel. +44 1942 845000  
Fax +44 1942 845091  
E-mail: sales@krones.co.uk

**India**

KRONES INDIA PVT. LTD.  
Appex Bldg, 1st Floor, 'A' wing  
#93/A, 4th 'B' Cross, 5th Block  
Koramangala Industrial Area  
560095 Bangalore  
Tel. +91 80 25715766/267  
Fax +91 80 25715768  
E-mail: krones@vsnl.com

**KRONES INDIA PVT. LTD.**

Branch Office:  
Unit No. 331, 3rd Floor  
Centrum Plaza, Golf Course Road  
Sector - 53, Gurgaon 122 002  
Tel. +91 124 4845200

**Indonesia**

KRONES INDONESIA  
Perwata Tower, 6th Floor, Suite-E  
CBD-Bluit  
Jl. Pluit Selatan Raya  
North Jakarta - 14440  
Tel. +62 21 5591 2877  
Fax +62 21 5591 2878  
E-mail: info@krones.co.id

**Italy**

KRONES S.R.L.  
Via L. Bacchini delle Palme, 2  
37016 Garda (VR)  
Tel. +39 045 6208222  
Fax +39 045 6208299  
E-mail: info@krones.it

**Japan**

KRONES JAPAN CO., LTD.  
Gibraltar Seimei Gotanda Bldg. 2F  
15-7 Nishi-Gotanda 2-chome  
Shinagawa-ku, Tokyo 141-0031  
Tel. +81 3 34912148  
Fax +81 3 34919213  
E-mail: sales@krones.co.jp

**Kazakhstan**

KRONES Representative Office  
Al-Farabi, 65  
050040 Almaty  
Tel. +7 7272 582568  
Fax +7 7272 582569  
E-mail: krones.kz@gmail.com

**Malaysia**

KRONES Representative Office  
Suite 4115, Level 41  
Vista Tower, The Intermark  
348, Jalan Tun Razak  
50400 Kuala Lumpur  
Tel. +60 (3) 2690 1458  
Fax +60 (3) 2690 1301

**Mexico**

KRONES MEX. S.A. DE C.V.  
Av. Horacio No. 828  
Col. Polanco  
11550 México, D. F.  
Tel. +52 55 72596800  
Fax +52 55 72596831  
E-mail: ventas@krones.com.mx

**Netherlands**

KRONES NEDERLAND B.V.  
Tolnasingel 1  
2411 PV Bodegraven  
Tel. +31 172 211514  
Fax +31 172 211526  
E-mail: sales@krones.nl

**China**

KRONES (BEIJING)  
REPRESENTATIVE OFFICE  
Room 1105, Jingtai Building  
No. 24 Jian Guo Men Wai Street  
Chao Yang District  
Beijing, 100022, P. R. China  
Tel. +86 10 65156365  
Fax +86 10 65156599  
E-mail: info@kronescn.com

**KRONES ASIA LTD.**

Unit 1102, 11/F,  
The Metropolis Tower,  
10 Metropolis Drive,  
Hungghom, Kowloon  
Hongkong/SAR  
Tel. +852 27 212618  
Fax +852 27 232598  
E-mail: info@krones.com.hk

**KRONES AG (SHANGHAI)**

REPRESENTATIVE OFFICE  
No. 03/13F, New Town Center  
83 Loushanguan Road  
Shanghai, 200336  
Tel. +86 21 62368380  
Fax +86 21 62368141  
E-mail: kronessh@sh163.net

**Philippines**

KRONES OFFICE MANILA  
30-A Hungary Street  
11711 Pranguey City  
Metro Manila  
Tel. +63 2 823-9913  
Fax +63 2 823-5316  
E-mail:  
adiego.krones@mydestiny.net

**Poland**

KRONES SPÓŁKA z o.o.  
ul. Puławska 303  
02-785 Warszawa  
Tel. +48 22 5494257  
Fax +48 22 5494251  
E-mail: biuro@krones.pl

**Portugal**

KRONES PORTUGAL, Lda.  
Rua Guerra Junqueiro, n° 6 E-F  
Rua de Baixo  
2730-092 Barcarena  
Tel. +351 21 4342500  
Fax +351 21 4342509  
E-mail: info@krones.pt

**Rep. of Southern Korea**

KRONES KOREA LTD.  
6 Fl. Seoil Bldg. 222,  
Jamsil-Dong, Songpa-gu  
Seoul, 135-220  
Tel. +82 2 22038920  
Fax +82 2 22030946  
E-mail: sales@krones.co.kr

**Rep. of South Africa**

KRONES S.A. (PTY) LTD.  
Stand 324 & 325 Avand Grand  
Northlands Deco Park  
Newmarket Street  
Northriding  
Randburg, 2194

**Postal Address:**

Private Bag X42  
Bryanston 2021  
Tel. +27 11 796-5230  
Fax +27 11 796-5099  
E-mail: KronesJHB@krones.co.za

**Romania**

KRONES ROMANIA  
PROD. S.R.L.  
Baneasa Business &  
Technology Park  
Building A, Wing A1,  
Ground Floor, Sector 1  
SOS. Bucuresti-Ploiesti Nr. 42-44  
013696 Bucuresti  
Tel. +40 21 213163539  
Fax +40 21 3160174  
E-mail:  
marioara.marculescu@krones.ro

**Russia**

KRONES o.o.o.  
2. Kasatschij per., 4, Geb. 1  
119180 Moskau  
Tel. +7 495 580-6630  
Fax +7 495 580-6631  
E-mail: krones@ru.krones.com

**Serbia**

KRONES AG  
Representative Office  
Omladinskih brigada 86  
Blok 65, 1. sprat  
11070 Novi Beograd  
Tel. +381 11 3188030  
Fax +381 11 3188029  
E-mail: sales@krones.rs

**Spain**

KRONES IBERICA, S.A.  
Provenza 30  
08029 Barcelona  
Tel. +34 93 4108185  
Fax +34-93 4107098  
E-mail: info@krones.es

**Switzerland**

KRONES AG  
Kapellenweg 5  
5632 Buttwil  
Tel. +41 56 6755040  
Fax +41 56 6644760  
E-mail: info@krones.ch

**Taiwan**

KRONES TAIWAN  
Sales Office Taiwan  
9th Floor, No. 29  
Alley 17, Kang Ro Street  
114 Taipei  
Tel. +886 9 2703-4315  
E-mail: cy.liang@krones.idv.tw

**Thailand**

KRONES (THAILAND) CO. LTD.  
39th Floor, Nation Tower  
1858/138 Bangna-Trad Road  
Bangna Sub District, Bangna District  
Bangkok, 10260  
Tel. +66 2 7636 500  
Fax +66 2 7636 502  
E-mail: sales@kronesthailand.com

**Turkey**

KRONES TÜRKIYE  
Ali Rıza Gurcan Cad.  
Metropol Center A Blok  
No. 32 Kat 13/51  
34010 Merter/Istanbul  
Tel. +90 212 4817474  
Fax +90-212 4817476  
E-mail: sales@krones.com.tr

**Ukraine**

KRONES UKRAINE  
Shota Rustaveli vul. 12, office 11  
01001 Kyiv  
Tel. +38 044 5023697  
E-mail: info@krones.com.ua

**USA**

KRONES, INC.  
9600 South 58th Street  
Franklin, Wis. 53132-6241  
Tel. +1 414 409-4000  
Fax +1 414 409-4100  
E-mail: salesusa@kronesusa.com

**Venezuela**

MAQUINARIAS KRONES  
DE VENEZUELA, S.A.  
Calle Centro  
Torre Mega IV  
Piso 1, Of 1-A  
Los Dos Caminos  
Tel. +58 212 2392257  
Fax +58 212 9763772

**Vietnam**

KRONES Representative Office  
Ho Chi Minh City  
Citylight Building  
Room 1204, 45 Vo Thi Sau Street  
District 1, Ho-Chi-Minh City  
Tel. +84 8 6290 6082/83/84  
Fax +84 8 6290 6087  
E-mail: thuy@kronesvn.com

**KRONES Representative Office**

Office Hanoi  
The Manor Tower  
Room 314A, 3rd Floor  
Medinh Street, Me Tri  
Lu Liem District, Hanoi  
Tel. +84 4 3766 6946/47  
Fax +84 4 3766 6948  
E-mail:  
tung.nguyen@kronesvn.com